



2016  
JOURNEY  
USER  
GUIDE





## IMPORTANT

This User Guide is intended to familiarize you with the important features of your vehicle. The DVD enclosed contains your Owner's Manual, Navigation/Uconnect Manuals, Warranty Booklets, Tire Warranty and Roadside Assistance (new vehicles purchased in the U.S.) or Roadside Assistance (new vehicles purchased in Canada) in electronic format. We hope you find it useful. U.S. residents can purchase replacement DVD kits by visiting [www.techauthority.com](http://www.techauthority.com) and Canadian residents can purchase replacement DVD kits by calling 1-800-387-1143.

If you are the first registered retail owner of your vehicle, you may obtain a complimentary printed copy of the Owner's Manual, Navigation/Uconnect Manuals or Warranty Booklet by calling 1-800-423-6343 (U.S.) or 1-800-387-1143 (Canada) or by contacting your dealer.



The driver's primary responsibility is the safe operation of the vehicle. Driving while distracted can result in loss of vehicle control, resulting in a collision and personal injury. FCA US LLC strongly recommends that the driver use extreme caution when using any device or feature that may take their attention off the road. Use of any electrical devices, such as cellular telephones, computers, portable radios, vehicle navigation or other devices, by the driver while the

vehicle is moving is dangerous and could lead to a serious collision. Texting while driving is also dangerous and should never be done while the vehicle is moving. If you find yourself unable to devote your full attention to vehicle operation, pull off the road to a safe location and stop your vehicle. Some states or provinces prohibit the use of cellular telephones or texting while driving. It is always the driver's responsibility to comply with all local laws.

# TABLE OF CONTENTS

## INTRODUCTION/WELCOME

WELCOME FROM FCA US LLC	2
-------------------------	---

## CONTROLS AT A GLANCE

DRIVER COCKPIT	4
INSTRUMENT CLUSTER	6

## GETTING STARTED

KEY FOB	8
REMOTE START	9
KEYLESS ENTER-N-GO	10
VEHICLE SECURITY ALARM	14
SEAT BELT SYSTEMS	14
SUPPLEMENTAL RESTRAINT SYSTEM (SRS) — AIR BAGS	15
CHILD RESTRAINTS	19
HEAD RESTRAINTS	26
FRONT SEATS	28
REAR SEATS	31
HEATED SEATS	33
HEATED STEERING WHEEL	34
TILT/TELESCOPING STEERING COLUMN	35

## OPERATING YOUR VEHICLE

ENGINE BREAK-IN RECOMMENDATIONS	36
TURN SIGNAL/WIPER/WASHER/HIGH BEAM LEVER	37
HEADLIGHT SWITCH	38
ELECTRONIC SPEED CONTROL	39
CLIMATE CONTROL	41
PARKVIEW REAR BACK-UP CAMERA	45
POWER SUNROOF	46
WIND BUFFETING	47

## ELECTRONICS

YOUR VEHICLE'S SOUND SYSTEM	48
CYBERSECURITY	50
IDENTIFYING YOUR RADIO	51
UCONNECT 4.3 & 4.3S AT A GLANCE	52
UCONNECT 8.4 & 8.4N AT A GLANCE	54
RADIO	56
SIRIUSXM SATELLITE RADIO	58
IPOD/CD/AUX CONTROLS	61
GARMIN NAVIGATION	63
SIRIUSXM TRAVEL LINK	66
PLAYING IPOD/USB/MP3 DEVICES	67
UCONNECT PHONE	68
UCONNECT VOICE COMMAND (8.4 & 8.4N ONLY)	75
VIDEO ENTERTAINMENT SYSTEM (VES)	77
STEERING WHEEL AUDIO CONTROLS	78
ELECTRONIC VEHICLE INFORMATION CENTER (EVIC)	79
PROGRAMMABLE FEATURES	80
UNIVERSAL GARAGE DOOR OPENER (HOMELINK)	81
POWER INVERTER	84
POWER OUTLETS	85

## UTILITY

TRAILER TOWING WEIGHTS (MAXIMUM TRAILER WEIGHT RATINGS)	87
RECREATIONAL TOWING (BEHIND MOTORHOME, ETC.)	88

## WHAT TO DO IN EMERGENCIES

ROADSIDE ASSISTANCE	89
INSTRUMENT CLUSTER WARNING LIGHTS	89
INSTRUMENT CLUSTER INDICATOR LIGHTS	94
IF YOUR ENGINE OVERHEATS	95
JACKING AND TIRE CHANGING	96
JUMP-STARTING	104
GEAR SELECTOR OVERRIDE	106
TOWING A DISABLED VEHICLE	107
FREEDOM A STUCK VEHICLE	107
ENHANCED ACCIDENT RESPONSE SYSTEM (EARS)	108
EVENT DATA RECORDER (EDR)	108

## MAINTAINING YOUR VEHICLE

OPENING THE HOOD	109
ENGINE COMPARTMENT — 2.4L	110
ENGINE COMPARTMENT — 3.6L	112
FLUID CAPACITIES	114
FLUIDS, LUBRICANTS, AND GENUINE PARTS	114
FLEXIBLE FUEL (3.6L ENGINE ONLY) — IF EQUIPPED	115
MAINTENANCE PROCEDURES	116
MAINTENANCE SCHEDULE	116
FUSES	121
TIRES — GENERAL INFORMATION	124
REPLACEMENT BULBS	127

## CONSUMER ASSISTANCE

FCA US LLC CUSTOMER CENTER	128
FCA CANADA INC. CUSTOMER CENTER	128
ASSISTANCE FOR THE HEARING IMPAIRED	128
PUBLICATIONS ORDERING	128
REPORTING SAFETY DEFECTS IN THE UNITED STATES	129

## MOPAR® ACCESSORIES

AUTHENTIC ACCESSORIES BY MOPAR	130
--------------------------------	-----

## FREQUENTLY ASKED QUESTIONS

FAQ's	131
-------	-----

INDEX	132
-------	-----



# INTRODUCTION/WELCOME

## WELCOME FROM FCA US LLC

Congratulations on selecting your new FCA US LLC ("FCA US") vehicle. Be assured that it represents precision workmanship, distinctive styling, and high quality - all essentials that are traditional to our vehicles.

Your new FCA US vehicle has characteristics to enhance the driver's control under some driving conditions. These are to assist the driver and are never a substitute for attentive driving. They can never take the driver's place. Always drive carefully.

Your new vehicle has many features for the comfort and convenience of you and your passengers. Some of these should not be used when driving because they take your eyes from the road or your attention from driving. Never text while driving or take your eyes more than momentarily off the road.

This guide illustrates and describes the operation of features and equipment that are either standard or optional on this vehicle. This guide may also include a description of features and equipment that are no longer available or were not ordered on this vehicle. Please disregard any features and equipment described in this guide that are not available on this vehicle. FCA US reserves the right to make changes in design and specifications and/or make additions to or improvements to its products without imposing any obligation upon itself to install them on products previously manufactured.

This User Guide has been prepared to help you quickly become acquainted with the important features of your vehicle. It contains most things you will need to operate and maintain the vehicle, including emergency information.

The DVD includes a computer application containing detailed Owner's information which can be viewed on a personal computer or MAC computer. The multimedia DVD also includes videos which can be played on any standard DVD player (including the Uconnect Touchscreen Radios if equipped with DVD player capabilities). Additional DVD operational information is located on the back of the DVD sleeve.

**For complete owner information, refer to your Owner's Manual on the DVD in the owner's kit provided at the time of new vehicle purchase.** For your convenience, the information contained on the DVD may also be printed and saved for future reference.

FCA US is committed to protecting our environment and natural resources. By converting from paper to electronic delivery for the majority of the user information for your vehicle, together we greatly reduce the demand for tree-based products and lessen the stress on our environment.

# INTRODUCTION/WELCOME

## VEHICLES SOLD IN CANADA

With respect to any vehicles sold in Canada, the name FCA US LLC shall be deemed to be deleted and the name FCA Canada Inc. used in substitution (excluding legal lines).

### WARNING!

- Pedals that cannot move freely can cause loss of vehicle control and increase the risk of serious personal injury.
- Always make sure that objects cannot fall into the driver foot well while the vehicle is moving. Objects can become trapped under the brake pedal and accelerator pedal causing a loss of vehicle control.
- Failure to properly follow floor mat installation or mounting can cause interference with the brake pedal and accelerator pedal operation causing loss of control of the vehicle.
- Never leave children alone in a vehicle, or with access to an unlocked vehicle. Allowing children to be in a vehicle unattended is dangerous for a number of reasons. A child or others could be seriously or fatally injured. Children should be warned not to touch the parking brake, brake pedal or the transmission gear selector.
- Do not leave the key fob in or near the vehicle, or in a location accessible to children. A child could operate power windows, other controls, or move the vehicle.
- Never use the 'PARK' position as a substitute for the parking brake. Always apply the parking brake fully when parked to guard against vehicle movement and possible injury or damage.
- Refer to your Owner's Manual on the DVD for further details.

## USE OF AFTERMARKET PRODUCTS (ELECTRONICS)

The use of aftermarket devices including cell phones, MP3 players, GPS systems, or chargers may affect the performance of on-board wireless features including Keyless Enter-N-Go and Remote Start range. If you are experiencing difficulties with any of your wireless features, try disconnecting your aftermarket devices to see if the situation improves. If your symptoms persist, please see an authorized dealer.

When it comes to service, remember that your authorized dealer knows your vehicle best, has factory-trained technicians and genuine MOPAR® parts, and cares about your satisfaction.



# CONTROLS AT A GLANCE

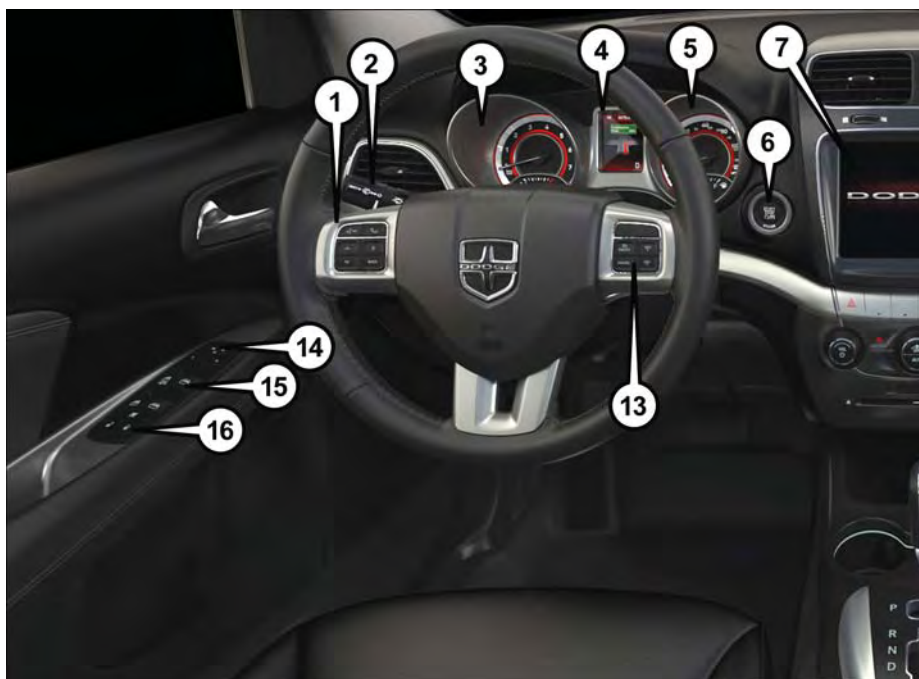

## DRIVER COCKPIT

1. Electronic Vehicle Information Center (EVIC) Controls pg. 79
2. Turn Signal/Light Lever pg. 37
3. Instrument Cluster pg. 6
4. Electronic Vehicle Information Center (EVIC) Display pg. 6
5. Speedometer
6. Engine Start/Stop Button pg. 12
7. Your Vehicle's Sound System pg. 48
8. Storage Compartment

# CONTROLS AT A GLANCE

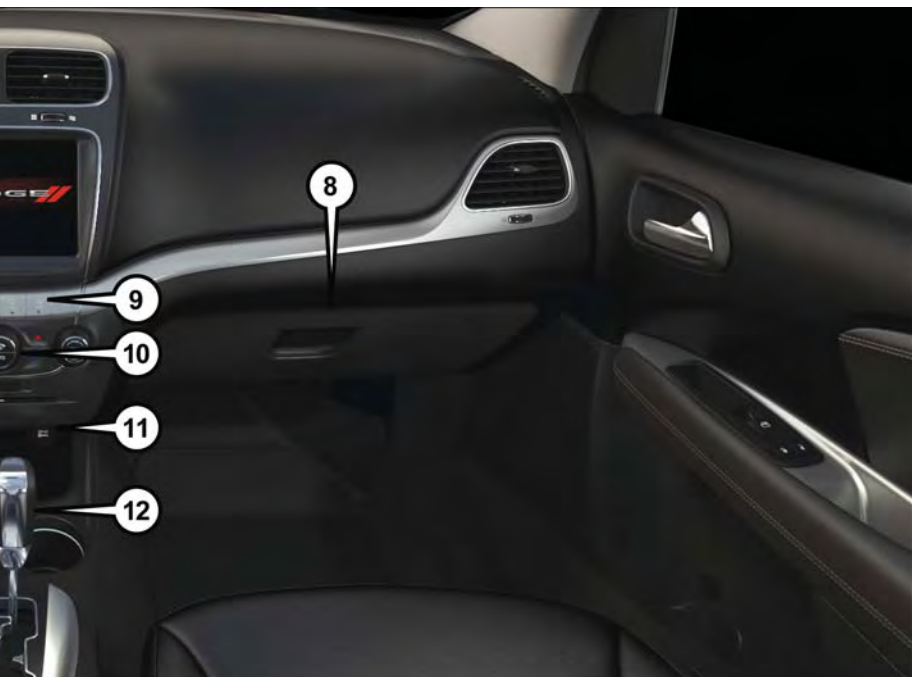

## 9. Switch Panel

- Hazard Switch
- Rear Defroster pg. 43
- Electronic Stability Control (ESC) OFF Indicator Light pg. 94
- Air Recirculation pg. 44

## 10. Climate Controls pg. 41

## 11. Power Outlet pg. 85

## 12. Transmission Gear Selector

## 13. Speed Controls pg. 39

## 14. Power Mirror Switch

## 15. Power Windows

## 16. Power Door Locks

# CONTROLS AT A GLANCE



## INSTRUMENT CLUSTER

1. Temperature Gauge
2. Tachometer
3. Electronic Vehicle Information Center (EVIC) Display

(See page 89 for Instrument Cluster Warning Light information.)



# CONTROLS AT A GLANCE



4. Fuel Gauge
5. Speedometer
6. Fuel Filler Door Location

(See page 94 for Instrument Cluster Indicator Lights information.)

# GETTING STARTED

## KEY FOB

### Locking And Unlocking The Doors And Liftgate

#### Lock The Doors And Liftgate

Push and release the LOCK button on the RKE transmitter to lock all doors and liftgate. The turn signal lights will flash, and the horn will chirp to acknowledge the signal.

#### Unlock The Doors And Liftgate

Push and release the UNLOCK button on the RKE transmitter once to unlock the driver's door or twice within five seconds to unlock all doors and liftgate. The turn signal lights will flash to acknowledge the unlock signal. The illuminated entry system will also turn on.

All doors can be programmed to unlock on the first push of the UNLOCK button. Refer to "Electronic Vehicle Information Center (EVIC) Customer Programmable Features" in "Electronics" for further information.



Key Fob

- 1 — Unlock
- 2 — Lock
- 3 — Remote Start
- 4 — Panic Button
- 5 — Emergency Key

### Panic Alarm

1. Push the PANIC button once to turn the Panic Alarm on.
2. Wait approximately three seconds and push the button a second time to turn the Panic Alarm off.

### Emergency Key

Should the battery in the vehicle or the Key Fob transmitter go dead, there is an emergency key located in the Key Fob. To remove the emergency key, slide the button at the back of the Key Fob sideways with your thumb and then pull the key out with your other hand.

## WARNING!

- When leaving the vehicle, always remove the Key Fob from the ignition and lock your vehicle.
- Never leave children alone in a vehicle, or with access to an unlocked vehicle. Allowing children to be in a vehicle unattended is dangerous for a number of reasons. A child or others could be seriously or fatally injured. Children should be warned not to touch the parking brake, brake pedal or the transmission gear selector.
- Do not leave the Key Fob in or near the vehicle (or in a location accessible to children), and do not leave the ignition of a vehicle equipped with Keyless Enter-N-Go in the ACC or ON/RUN mode. A child could operate power windows, other controls, or move the vehicle.

## REMOTE START

Push the REMOTE START button  on the Key Fob twice within five seconds. Pushing the REMOTE START button a third time shuts the engine off.

To drive the vehicle, push the UNLOCK button and cycle the ignition to the ON/RUN position.

With remote start, the engine will only run for 15 minutes (timeout) unless the ignition is cycled to the ON/RUN position.

The vehicle must be cycled to the ON/RUN position after two consecutive timeouts.

## WARNING!

- Do not start or run an engine in a closed garage or confined area. Exhaust gas contains Carbon Monoxide (CO) which is odorless and colorless. Carbon Monoxide is poisonous and can cause you or others to be severely injured or killed when inhaled.
- Keep Key Fob transmitters away from children. Operation of the Remote Start System, windows, door locks or other controls could cause you and others to be severely injured or killed.

# GETTING STARTED

## KEYLESS ENTER-N-GO

The Keyless Enter-N-Go system is an enhancement to the vehicle's Remote Keyless Entry (RKE) feature. This feature allows you to lock and unlock the vehicle's door(s) and liftgate without having to push the Key Fob LOCK or UNLOCK buttons, as well as starting and stopping the vehicle with the push of a button.

### To Unlock From The Driver Or Passenger Side:

With a valid Keyless Enter-N-Go Key Fob located outside the vehicle and within 5 ft (1.5 m) of the driver or passenger side door handle, grab either front door handle to unlock the door automatically.



**Grab The Door Handle To Unlock**

## To Lock The Vehicle:

Both front door handles have buttons located on the outside of the handle. With one of the vehicle's Keyless Enter-N-Go Key Fobs located outside the vehicle and within 5 ft (1.5m) of the driver's or passenger front door handle, push the door handle button to lock all four doors and liftgate.

Do NOT grab the door handle when pushing the door handle lock button. This could unlock the door(s).



**Push The Door Handle Button To Lock**

### NOTE:



**Do NOT Grab The Handle When Locking**

- If “Unlock All Doors 1st Press” is programmed, all doors will unlock when you grab hold of the front driver's door handle. To select between “Unlock Driver Door 1st Press” and “Unlock All Doors 1st Press,” refer to the “Uconnect Settings” in your vehicle's Owner's Manual on the DVD or “Programmable Features” in this guide for further information.
- If “Unlock All Doors 1st Press” is programmed, all doors and liftgate will unlock when you push the liftgate button. If “Unlock Driver Door 1st Press” is programmed, only the liftgate will unlock when you push the liftgate button. To select between “Unlock Driver Door 1st Press” and “Unlock All Doors 1st Press,” refer to the “Uconnect Settings” in your vehicle's Owner's Manual on the DVD or “Programmable Features” in this guide for further information.
- If a Key Fob is detected in the vehicle when locking the vehicle using the power door lock switch, the doors and liftgate will unlock and the horn will chirp three times. On the third attempt, your Key Fob can be locked inside the vehicle.
- After pushing the Keyless Enter-N-Go LOCK button, you must wait two seconds before you can lock or unlock the vehicle using the door handle. This is done to allow you to check if the vehicle is locked by pulling the door handle without the vehicle reacting and unlocking.

# GETTING STARTED

## Lock Or Unlock The Liftgate:

With a valid Keyless Enter-N-Go Key Fob within 3 feet (1 meter) of the liftgate, push the electronic liftgate lock/unlock pad located to the left of the liftgate handle to unlock the liftgate. Push the button a second time to lock the liftgate.

### NOTE:

Refer to your Owner's Manual on the DVD for further information.



1 — Electronic Liftgate Lock/Unlock Pad

## ENGINE STARTING/STOPPING

### Starting

With a valid Keyless Enter-N-Go Key Fob inside the vehicle.

Place the shift lever in PARK or NEUTRAL.

While pushing the brake pedal, push the ENGINE START/STOP button once. If the engine fails to start, the starter will disengage automatically after 10 seconds.

To stop the cranking of the engine prior to the engine starting, push the button again.

### NOTE:

In case the ignition switch does not change with the push of a button, the RKE transmitter (Key Fob) may have a low or dead battery. In this situation, a back up method can be used to operate the ignition switch. Put the nose side of the Key Fob against the ENGINE START/STOP button and push to operate the ignition switch.



Engine Start/Stop Button

## Stopping

Place the shift lever in PARK.

Push the ENGINE START/STOP button once. The ignition switch will return to the OFF position.

**If the shift lever is not in PARK, the ENGINE START/STOP button must be held for two seconds and vehicle speed must be above 5 MPH (8 km/h) before the engine will shut off.**

## Accessory Positions With Engine Off

### NOTE:

The following functions are with the driver's foot OFF the Brake Pedal (Transmission in PARK or NEUTRAL Position).

### Starting With The Ignition Switch In The OFF Position:

1. Push the ENGINE START/STOP button once to change the ignition switch to the ACC position.
2. Push the ENGINE START/STOP button a second time to change the ignition switch to the ON/RUN position.
3. Push the ENGINE START/STOP button a third time to return the ignition switch to the OFF position.

### NOTE:

If the ignition switch is left in the ACC or ON/RUN (engine not running) position and the transmission is in PARK, the system will automatically time out after 30 minutes of inactivity and the ignition will switch to the OFF position.

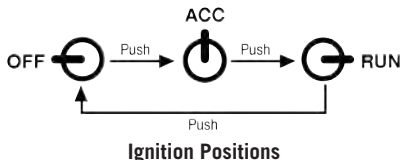

In case the ignition switch does not change with the push of a button, the RKE transmitter (Key Fob) may have a low or dead battery. In this situation, a back up method can be used to operate the ignition switch. Put the nose side (side opposite of the emergency key) of the Key Fob against the ENGINE START/STOP button and push to operate the ignition switch.

# GETTING STARTED

## VEHICLE SECURITY ALARM

The Vehicle Security Alarm monitors the vehicle doors for unauthorized entry and the ignition for unauthorized operation. While the Vehicle Security Alarm is armed, interior switches for door locks and decklid release are disabled. If something triggers the alarm, the Vehicle Security Alarm will provide the following audible and visible signals: the horn will pulse, the park lamps and/or turn signals will flash, and the Vehicle Security Light in the instrument cluster will flash.

### To Arm

Push the Keyless Enter-N-Go START/STOP button until the Electronic Vehicle Information Center (EVIC) indicates that the vehicle ignition is "OFF." Push the power door lock switch while the door is open, push the Key Fob LOCK button, or with one of the Key Fobs located outside the vehicle and within 5 ft (1.5 m) of the driver's and passenger front door handles, push the Keyless Enter-N-Go LOCK button located on the door handle.

### NOTE:

After pushing the Keyless Enter-N-Go LOCK button, you must wait two seconds before you can lock or unlock the vehicle via the door handle.

### To Disarm

Push the Key Fob UNLOCK button or with one of the Key Fobs located outside the vehicle and within 5 ft (1.5 m) of the driver's and passenger front door handles, grab the Keyless Enter-N-Go door handle and enter the vehicle, then push the Keyless Enter-N-Go START/STOP button (requires at least one valid Key Fob in the vehicle).

## SEAT BELT SYSTEMS

### Lap/Shoulder Belts

All seating positions in your vehicle are equipped with lap/shoulder belts.

Be sure everyone in your vehicle is in a seat and using a seat belt properly.

Position the lap belt so that it is snug and lies low across your hips, below your abdomen. To remove slack in the lap belt portion, pull up on the shoulder belt. To loosen the lap belt if it is too tight, tilt the latch plate and pull on the lap belt. A snug seat belt reduces the risk of sliding under the seat belt in a collision.

Position the shoulder belt across the shoulder and chest with minimal, if any slack so that it is comfortable and not resting on your neck. The retractor will withdraw any slack in the shoulder belt.

### Seat Belt Pretensioner

The front seat belt system is equipped with pretensioning devices that are designed to remove slack from the seat belt in the event of a collision.

A deployed pretensioner or a deployed air bag must be replaced immediately.



## WARNING!

- In a collision, you and your passengers can suffer much greater injuries if you are not properly buckled up. You can strike the interior of your vehicle or other passengers, or you can be thrown out of the vehicle. Always be sure you and others in your vehicle are buckled up properly.
- A shoulder belt placed behind you will not protect you from injury during a collision. You are more likely to hit your head in a collision if you do not wear your shoulder belt. The lap and shoulder belt are meant to be used together.
- A seat belt that is too loose will not protect you properly. In a sudden stop, you could move too far forward, increasing the possibility of injury. Wear your seat belt snugly.
- A frayed or torn seat belt could rip apart in a collision and leave you with no protection. Inspect the seat belt system periodically, checking for cuts, frays, or loose parts. Damaged parts must be replaced immediately. Do not disassemble or modify the system. Seat belt assemblies must be replaced after a collision.

## SUPPLEMENTAL RESTRAINT SYSTEM (SRS) — AIR BAGS

### Air Bag System Components

Your vehicle may be equipped with the following air bag system components:

- Occupant Restraint Controller (ORC)
- Air Bag Warning Light 
- Steering Wheel and Column
- Instrument Panel
- Knee Impact Bolsters
- Advanced Front Air Bags
- Supplemental Side Air Bags
- Supplemental Knee Air Bags
- Front and Side Impact Sensors
- Seat Belt Pretensioners
- Seat Belt Buckle Switch
- Seat Track Position Sensors

### Advanced Front Air Bags

This vehicle has Advanced Front Air Bags for both the driver and front passenger as a supplement to the seat belt restraint systems. The Advanced Front Air Bags will not deploy in every type of collision.

Advanced Front Air Bags are designed to provide additional protection by supplementing the seat belts. Advanced Front Air Bags are not expected to reduce the risk of injury in rear, side, or rollover collisions.

# GETTING STARTED

The Advanced Front Air Bags will not deploy in all frontal collisions, including some that may produce substantial vehicle damage — for example, some pole collisions, truck underrides, and angle offset collisions.

On the other hand, depending on the type and location of impact, Advanced Front Air Bags may deploy in crashes with little vehicle front-end damage but that produce a severe initial deceleration.

Because air bag sensors measure vehicle deceleration over time, vehicle speed and damage by themselves are not good indicators of whether or not an air bag should have deployed.

Seat belts are necessary for your protection in all collisions, and also are needed to help keep you in position, away from an inflating air bag.

After any collision, the vehicle should be taken to an authorized dealer immediately.

Do not drive your vehicle after the air bags have deployed. If you are involved in another collision, the air bags will not be in place to protect you.

Refer to the Owner's Manual on the DVD for further details regarding the Supplemental Restraint System (SRS).

If it is necessary to modify the air bag system for persons with disabilities, contact your authorized dealer.

## Supplemental Knee Air Bags

This vehicle is equipped with a Supplemental Driver Knee Air Bag mounted in the instrument panel below the steering column. The Supplemental Driver Knee Air Bag provides enhanced protection during a frontal impact by working together with the seat belts, pretensioners, and Advanced Front Air Bags.

### WARNING!

- Relying on the air bags alone could lead to more severe injuries in a collision. The air bags work with your seat belt to restrain you properly. In some collisions, the air bags won't deploy at all. Always wear your seat belts even though you have air bags.
- Being too close to the steering wheel or instrument panel during Advanced Front Air Bag deployment could cause serious injury, including death. Air bags need room to inflate. Sit back, comfortably extending your arms to reach the steering wheel or instrument panel.
- No objects should be placed over or near the air bag on the instrument panel or steering wheel because any such objects could cause harm if the vehicle is in a collision severe enough to cause the air bag to inflate.

## Supplemental Side Air Bags

This vehicle is equipped with Supplemental Seat-Mounted Side Air Bags (SABs) located in the outboard side of the front seats. The SABs are marked with a SRS AIRBAG or AIRBAG label sewn into the outboard side of the seats.

This vehicle is equipped with Supplemental Side Air Bag Inflatable Curtains (SABICs) located above the side windows. The trim covering the SABICs is labeled SRS AIRBAG or AIRBAG. The SABICs may help reduce the risk of partial or complete ejection of vehicle occupants through side windows in certain rollover or side impact events.

The SABICs and SABs (“Side Air Bags”) are designed to activate in certain side impacts and certain rollover events. The Occupant Restraint Controller (“ORC”) determines whether the deployment of the Side Air Bags in a particular side impact or rollover event is appropriate, based on the severity and type of collision. Vehicle damage by itself is not a good indicator of whether or not Side Air Bags should have deployed.

### WARNING!

- Side Air Bags need room to inflate. Do not lean against the door or window. Sit upright in the center of the seat.
- Being too close to the Side Air Bags during deployment could cause you to be severely injured or killed.
- Relying on the Side Air Bags alone could lead to more severe injuries in a collision. The Side Air Bags work with your seat belt to restrain you properly. In some collisions, Side Air Bags won’t deploy at all. Always wear your seat belt even though you have Side Air Bags.
- This vehicle is equipped with left and right Supplemental Side Air Bag Inflatable Curtains (SABICs). Do not stack luggage or other cargo up high enough to block the deployment of the SABICs. The trim covering above the side windows where the SABIC and its deployment path are located should remain free from any obstructions.
- This vehicle is equipped with SABICs. In order for the SABICs to work as intended, do not install any accessory items in your vehicle which could alter the roof. Do not add an aftermarket sunroof to your vehicle. Do not add roof racks that require permanent attachments (bolts or screws) for installation on the vehicle roof. Do not drill into the roof of the vehicle for any reason.
- Do not use accessory seat covers or place objects between you and the Side Air Bags; the performance could be adversely affected and/or objects could be pushed into you, causing serious injury.

# GETTING STARTED

## Enhanced Accident Response System

In the event of an impact, if the communication network remains intact, and the power remains intact, depending on the nature of the event, the ORC will determine whether to have the Enhanced Accident Response System perform the following functions:

- Cut off fuel to the engine.
- Flash hazard lights as long as the battery has power or until the hazard light button is pushed. The hazard lights can be deactivated by pushing the hazard light button.
- Turn on the interior lights, which remain on as long as the battery has power.
- Unlock the power door locks.

## Enhanced Accident Response System Reset Procedure

In order to reset the Enhanced Accident Response System functions after an event, the ignition switch must be changed from ignition START or ON/RUN to ignition OFF. Carefully check the vehicle for fuel leaks in the engine compartment and on the ground near the engine compartment and fuel tank before resetting the system and starting the engine.

## Air Bag Warning Light

The air bags must be ready to inflate for your protection in a collision. The Occupant Restraint Controller (ORC) monitors the internal circuits and interconnecting wiring associated with air bag system electrical components.

The ORC monitors the readiness of the electronic parts of the air bag system whenever the ignition switch is in the START or ON/RUN position. If the ignition switch is in the OFF position or in the ACC position, the air bag system is not on and the air bags will not inflate.

The ORC turns on the Air Bag Warning Light in the instrument panel for approximately four to eight seconds for a self-check when the ignition switch is first turned to the ON/RUN position. After the self-check, the Air Bag Warning Light will turn off. If the ORC detects a malfunction in any part of the system, it turns on the Air Bag Warning Light, either momentarily or continuously. A single chime will sound to alert you if the light comes on again after initial startup.

If the Air Bag Warning Light in the instrument panel is not on during the four to eight seconds when the ignition switch is first turned to the ON/RUN position, stays on, or turns on while driving, have the vehicle serviced by an authorized service center immediately.

### NOTE:

If the speedometer, tachometer, or any engine related gauges are not working, the Occupant Restraint Controller (ORC) may also be disabled. In this condition the air bags may not be ready to inflate for your protection. Have an authorized dealer service the air bag system immediately.

## Event Data Recorder (EDR)

This vehicle is equipped with an event data recorder (EDR). The main purpose of an EDR is to record, in certain crash or near crash-like situations, such as an air bag deployment or hitting a road obstacle, data that will assist in understanding how a vehicle's systems performed. The EDR is designed to record data related to vehicle dynamics and safety systems for a short period of time, typically 30 seconds or less. The EDR in this vehicle is designed to record such data as:

- How various systems in your vehicle were operating;
- Whether or not the driver and passenger safety belts were buckled/fastened;
- How far (if at all) the driver was depressing the accelerator and/or brake pedal; and,
- How fast the vehicle was traveling.

These data can help provide a better understanding of the circumstances in which crashes and injuries occur.

### NOTE:

EDR data are recorded by your vehicle only if a non-trivial crash situation occurs; no data are recorded by the EDR under normal driving conditions and no personal data (e.g., name, gender, age, and crash location) are recorded. However, other parties, such as law enforcement, could combine the EDR data with the type of personally identifying data routinely acquired during a crash investigation.

To read data recorded by an EDR, special equipment is required, and access to the vehicle or the EDR is needed. In addition to the vehicle manufacturer, other parties, such as law enforcement, that have the special equipment, can read the information if they have access to the vehicle or the EDR.

## CHILD RESTRAINTS

Children 12 years or younger should ride properly buckled up in a rear seat, if available. According to crash statistics, children are safer when properly restrained in the rear seats rather than in the front.

Every state in the United States and all Canadian provinces require that small children ride in proper restraint systems. This is the law, and you can be prosecuted for ignoring it.

### NOTE:

- For additional information, refer to [www.Seatcheck.org](http://www.Seatcheck.org) or call: 1-866-732-8243
- Canadian residents should refer to Transport Canada's website for additional information: <http://www.tc.gc.ca/eng/motorvehiclesafety/safedrivers-childsafety-index-53.htm>

# GETTING STARTED

## LATCH — Lower Anchors And Tethers For Children

Your vehicle is equipped with the child restraint anchorage system called LATCH, which stands for Lower Anchors and Tethers for CHildren.

The second row seating positions have lower anchors and top tether anchors. The third row seating positions (if equipped) do not have lower anchors or top tether anchors.

## LATCH System Weight Limit

You may use the LATCH anchorage system until the combined weight of the child and the child restraint is 65 lbs (29.5 kg). Use the seat belt and tether anchor instead of the LATCH system once the combined weight is more than 65 lbs (29.5 kg).

## Locating LATCH Anchorages

The lower anchorages are round bars that are found at the rear of the seat cushion where it meets the seatback. They are just visible when you lean into the rear seat to install the child restraint. You will easily feel them if you run your finger along the gap between the seatback and seat cushion.



1 — Lower Anchors

## Locating Tether Anchorages

In addition, there are tether strap anchors  located behind each second row seat-back, near the floor.

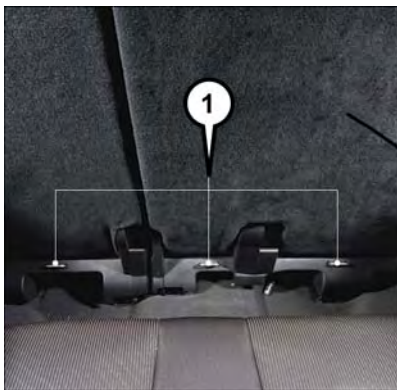

1 — Tether Anchorages

## Center Seat LATCH

The center seating position in this vehicle has a single dedicated anchorage. Use anchorages B and C to install a child seat in the center position. Do not use anchorages C and D to install a child seat. If you are installing three child restraints, you must use the seatbelt to install the center child restraint. You can use either the LATCH anchors or the vehicle's seat belt for installing the child seats in the outboard positions. See the vehicle owner's manual for more information about center LATCH.

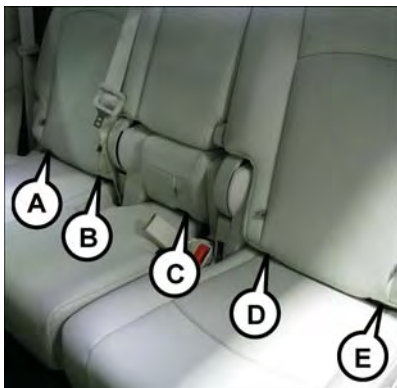

Lower Anchors

# GETTING STARTED

## Installing The Child Restraint Using The LATCH Lower Anchors

### NOTE:

Never “share” a LATCH anchorage with two or more child restraints.

1. Loosen the adjusters on the lower straps and on the tether strap of the child seat so that you can more easily attach the hooks or connectors to the vehicle anchorages.
2. Attach the lower hooks or connectors of the child restraint to the lower anchorages in the selected seating position.
3. If the child restraint has a tether strap, connect it to the top tether anchorage. See below for directions to attach a tether anchor.
4. Tighten all of the straps as you push the child restraint rearward and downward into the seat. Remove slack in the straps according to the child restraint manufacturer's instructions.
5. Test that the child restraint is installed tightly by pulling back and forth on the child seat at the belt path. It should not move more than 1 inch (25.4 mm) in any direction.

## Installing The Child Restraint Using The Vehicle Seat Belts

The seat belts in the outboard passenger seating positions are equipped with a Switchable Automatic Locking Retractor (ALR). The center seating positions are equipped with a cinching latch plate. Both types of seat belts are designed to keep the lap portion of the seat belt tight around the child restraint. Any seat belt system will loosen with time, so check the belt occasionally, and pull it tight if necessary.

### Tether Anchorage Weight Limit

Always use the tether anchor when using the seat belt to install a forward facing child restraint, up to the recommended weight limit of the child restraint.

### To Install A Child Seat Using An ALR

1. Pull enough of the seat belt webbing from the retractor to pass it through the belt path of the child restraint. Do not twist the belt webbing in the belt path.
2. Slide the latch plate into the buckle until you hear a “click.”
3. Pull on the webbing to make the lap portion tight against the child seat.
4. To lock the seat belt, pull down on the shoulder part of the belt until you have pulled all the seat belt webbing out of the retractor. Then, allow the webbing to retract back into the retractor. As the webbing retracts, you will hear a clicking sound. This means the seat belt is now in the Automatic Locking mode.
5. Try to pull the webbing out of the retractor. If it is locked, you should not be able to pull out any webbing. If the retractor is not locked, repeat the last step.



6. Finally, pull up on any extra webbing to tighten the lap portion around the child restraint while you push the child restraint rearward and downward into the vehicle seat.
7. If the child restraint has a top tether strap and the seating position has a top tether anchorage, connect the tether strap to the anchorage and tighten the tether strap. See below for directions to attach a tether anchor.
8. Test that the child restraint is installed tightly by pulling back and forth on the child seat at the belt path. It should not move more than 1 inch (25.4 mm) in any direction.

## **To Install A Child Seat Using A Cinching Latch Plate:**

1. Place the child seat in the center of the seating position.
2. Next, pull enough of the seat belt webbing from the retractor to pass it through the belt path of the child restraint. Do not twist the belt webbing in the belt path.
3. Slide the latch plate into the buckle until you hear a “click.”
4. Finally, pull up on any excess webbing to tighten the lap portion around the child restraint while you push the child restraint rearward and downward into the vehicle seat.
5. If the child restraint has a top tether strap and the seating position has a top tether anchorage, connect the tether strap to the anchorage and tighten the tether strap. See below for directions to attach a tether anchor.
6. Test that the child restraint is installed tightly by pulling back and forth on the child seat at the belt path. It should not move more than 1 inch (25.4 mm) in any direction.

## **Installing The Top Tether Strap (With Either Lower Anchors Or Vehicle Seat Belt)**

When installing a forward-facing child restraint, always secure the top tether strap, up to the tether anchor weight limit, whether the child restraint is installed with the lower anchors or the vehicle seat belt.

### **Tether Anchorage Strap Installation**

1. Route the tether strap to provide the most direct path for the strap between the anchor and the child seat.
2. If your vehicle is equipped with adjustable rear head restraints, raise the head restraint, and where possible, route the tether strap under the head restraint and between the two posts. If not possible, lower the head restraint and pass the tether strap around the outboard side of the head restraint.

# GETTING STARTED

3. Attach the tether strap hook of the child restraint to the top tether anchorage and remove slack in the tether strap according to the child restraint manufacturer's instructions.



**Rear Seat Tether Strap Mounting**

## **Integrated Child Booster Seat — If Equipped**

The Integrated Child Booster Seat is located in each outboard second-row passenger seat. Refer to the Integrated Child Booster Seat information label located on the front lower panel of the opened Booster Seat for child height and weight specifications.

To position a child into the Integrated Child Booster Seat follow these steps:

1. Slide the second row seat to the full rear position to use the Integrated Child Booster Seat. NOTE: The second row bench with Integrated Child Booster Seat must remain in the full rear position during use.
2. Pull the release loop forward to release the latch and seat cushion.



**Pull The Booster Seat Release Loop**

3. Lift the seat cushion up and push back to lock it in the booster seat position.
4. Place the child upright in the seat with their back firmly against the seatback.
5. Grasp the latch plate and pull out the seat belt.
6. Slide the latch plate up the webbing as far as necessary to allow the seat belt to go around the child's lap. NOTE: The lap portion of the seat belt should be low on the hips and as snug as possible.
7. Once the seat belt is long enough to fit properly, insert the latch plate into the buckle until you hear a "click."
8. To remove the slack from the lap belt, pull upward on the shoulder portion of the seat belt.
9. To release the seat belt, push the red button on the buckle.



**Booster Seat Locked In Position**

## **WARNING!**

Securely lock the seat cushion into position before using the seat. Otherwise, the seat will not provide the proper stability for child seats and/or passengers. An improperly latched seat cushion could cause serious injury or death.

## **WARNING!**

- In a collision, an unrestrained child, even a tiny baby, can become a projectile inside the vehicle. The force required to hold even an infant on your lap could become so great that you could not hold the child, no matter how strong you are. The child and others could be severely injured or killed. Any child riding in your vehicle should be in a proper restraint for the child's size.
- Never place a rear-facing child restraint in front of an air bag. A deploying Passenger Advanced Front Air Bag can cause death or serious injury to a child 12 years or younger, including a child in a rear-facing child restraint.
- Only use a rear-facing child restraint in a vehicle with a rear seat.
- Improper installation of a child restraint to the LATCH anchorages can lead to failure of an infant or child restraint. The child could be severely injured or killed. Follow the manufacturer's directions exactly when installing an infant or child restraint.
- An incorrectly anchored tether strap could lead to increased head motion and possible injury to the child. Use only the anchor positions directly behind the child seat to secure a child restraint top tether strap.
- If your vehicle is equipped with a split rear seat, make sure the tether strap does not slip into the opening between the seatbacks as you remove slack in the strap.

# GETTING STARTED

## HEAD RESTRAINTS

Head restraints are designed to reduce the risk of injury by restricting head movement in the event of a rear impact. Head restraints should be adjusted so that the top of the head restraint is located above the top of your ear.

### WARNING!

The head restraints for all occupants must be properly adjusted prior to operating the vehicle or occupying a seat. Head restraints should never be adjusted while the vehicle is in motion. Driving a vehicle with the head restraints improperly adjusted or removed could cause serious injury or death in the event of a collision.

### Supplemental Active Head Restraints (AHR) — Front Seats

Supplemental Active Head Restraints are passive, deployable components, and vehicles with this equipment can not be readily identified by any markings, only through visual inspection of the head restraint. The head restraint will be split in two halves, with the front half being soft foam and trim, the back half being decorative plastic.

When AHRs deploy during a rear impact, the front half of the head restraint extends forward to minimize the gap between the back of the occupant's head and the AHR. This system is designed to help prevent or reduce the extent of injuries to the driver and front passenger in certain types of rear impacts. Refer to "Occupant Restraints" in "Things To Know Before Starting" in the Owner's Manual on the DVD for further information.

To raise the head restraint, pull upward on the head restraint. To lower the head restraint, push the adjustment button, located at the base of the head restraint, and push downward on the head restraint.

For comfort, the Active Head Restraints can be tilted forward and backward. To tilt the head restraint closer to the back of your head, pull forward on the bottom of the head restraint. Push rearward on the bottom of the head restraint to move the head restraint away from your head.

### NOTE:

- The head restraints should only be removed by qualified technicians, for service purposes only. If either of the head restraints require removal, see your authorized dealer.
- In the event of deployment of an Active Head Restraint, refer to "Occupant Restraints/ Supplemental Active Head Restraints (AHR)/Resetting Active Head Restraints (AHR)" in "Things To Know Before Starting" in the Owner's Manual on the DVD for further information.

## WARNING!

- All occupants, including the driver, should not operate a vehicle or sit in a vehicle's seat until the head restraints are placed in their proper positions in order to minimize the risk of neck injury in the event of a collision.
- Do not place items over the top of the Active Head Restraint, such as coats, seat covers or portable DVD players. These items may interfere with the operation of the Active Head Restraint in the event of a collision and could result in serious injury or death.
- Active Head Restraints may be deployed if they are struck by an object such as a hand, foot or loose cargo. To avoid accidental deployment of the Active Head Restraint ensure that all cargo is secured, as loose cargo could contact the Active Head Restraint during sudden stops. Failure to follow this warning could cause personal injury if the Active Head Restraint is deployed.

### Head Restraints — Second Row Seats

The second row seats are equipped with adjustable and removable head restraints. To raise the head restraint, pull upward on the head restraint. To lower the head restraint, push the adjustment button located on the base of the head restraint, and push downward on the head restraint.

## WARNING!

A loose head restraint thrown forward in a collision or hard stop could cause serious injury or death to occupants of the vehicle. Always securely stow removed head restraints in a location outside the occupant compartment.

To remove the head restraint, push the adjustment and the release buttons while pulling upward on the whole assembly and raise it up as far as it can go. To reinstall the headrest, put the headrest posts into the holes while pushing the release buttons. Then adjust it to the appropriate height.

## WARNING!

ALL the head restraints MUST be reinstalled in the vehicle to properly protect the occupants. Follow the re-installation instructions above prior to operating the vehicle or occupying a seat.

### NOTE:

For proper routing of a Child Seat Tether, refer to "Occupant Restraints" in "Things To Know Before Starting" in the Owner's Manual on the DVD for further information.

# GETTING STARTED

## WARNING!

Driving a vehicle with the head restraints removed or improperly adjusted could cause serious injury or death in the event of a collision. The head restraints should be checked prior to operating the vehicle and never adjusted while the vehicle is in motion.

### Third Row Passenger Seats — Seven Passenger Models

These head restraints are non-adjustable and non-removable. However, you can fold them forward when they are not in use by passengers. Refer to “50/50 Split Third-Row Passenger Seats With Fold-Flat Feature — Seven Passenger Models” in the Owner’s Manual on the DVD for further information.

## WARNING!

Do not allow a passenger to sit in a third row seat without having the head restraint unfolded and locked in place. Failure to follow this warning may result in personal injury to the passenger in the event of a collision.

## FRONT SEATS

### Power Seats

The power seat switch, located on the out-board side of the seat near the floor, controls forward/back, up/down, and tilt adjustment.



Power Seat

- 1 — Power Seat Switch
- 2 — Recliner Lever

## Power Lumbar

Push the switch forward to increase the lumbar support. Push the switch rearward to decrease the lumbar support.

Pushing upward or downward on the switch will raise and lower the position of the support.



Power Lumbar Switch

## Manual Seat Adjustment

### Forward/Rearward

Lift up on the adjusting bar located at the front of the seat near the floor and release it when the seat is at the desired position. Then, using body pressure, move forward and backward on the seat to be sure that the seat adjusters have latched.

### Recliner

Lift the recliner lever located on the out-board side of the seat, lean back and release at the desired position.



Adjusting Bar/Recliner Lever Location

- 1 — Recliner Lever
- 2 — Adjusting Bar

# GETTING STARTED

## Fold-Flat Front Passenger Seat

The front passenger seat can be folded flat to allow for extended cargo space. Pull up on the recliner lever to fold down the seat-back.



Passenger Seat Folded Position

## Flip 'n Stow Front Passenger Seat Storage

The seat latch release-loop is located in the center of the seat cushion between the seat cushion and the seatback. Pull the loop upward to release the latch and then forward to open the seat to the detent position.

### NOTE:

Make sure that objects inside the bin do not interfere with the latch before closing the seat. Push the seat cushion downward after closing it to make sure it latches to the base.



Passenger Seat Storage

### CAUTION!

Do not place any article under a power seat or impede its ability to move as it may cause damage to the seat controls. Seat travel may become limited if movement is stopped by an obstruction in the seat's path.



## WARNING!

- Adjusting a seat while the vehicle is moving is dangerous. The sudden movement of the seat could cause you to lose control. The seat belt might not be properly adjusted, and you could be severely injured or killed. Only adjust a seat while the vehicle is parked.
- Do not ride with the seatback reclined so that the seat belt is no longer resting against your chest. In a collision, you could slide under the seat belt and be severely injured or killed. Use the recliner only when the vehicle is parked.
- Be certain that the seat cushion is locked securely into position before using the seat. Otherwise, the seat will not provide the proper stability for passengers. An improperly latched seat cushion could cause serious injury.

## REAR SEATS

### 60/40 SPLIT SECOND-ROW PASSENGER SEATS

#### To Lower The Seatback

1. Locate the seatback release lever on the lower outboard side of the seat.
2. Place one hand on the seatback and apply a gentle pressure.
3. Lift the seatback release lever with the other hand, allowing the seatback to move forward slightly, and then release the lever.
4. Gently guide the seatback into the folded position.

#### To Raise The Seatback

Raise the seatback and lock it in place.

#### Forward And Rearward Adjustment

The control lever is on the outboard side of the seat. Lift the lever to move the seat forward or rearward. Release the lever once the seat is in the position desired.

#### Recliner Adjustment

The seatback release lever is on the outboard side of the seat. To recline the seat, lean back, lift the lever, position the seatback as desired, and then release the lever. To return the seatback to its normal upright position, lean back, lift the lever, lean forward, and then release the lever once the seatback is in the upright position.



Rear Seat Lever Locations

- 1 — Forward/Rearward Adjustment Lever
- 2 — Recliner/Seatback Release Lever
- 3 — Tip 'n Slide Control Lever

# GETTING STARTED

## STADIUM Tip 'n Slide (EASY ENTRY/EXIT SEAT) — SEVEN PASSENGER MODELS

### To Move The Second-Row Passenger Seat Forward

#### NOTE:

Raise the 20% seatback/armrest before moving the 60% seat to allow for full seat travel.

To allow passengers to easily enter or exit the third-row passenger seats move the Tip 'n Slide control lever on the upper outboard side of the seatback forward, and in one fluid motion, the seat cushion flips upward and the seat moves forward on its tracks.

### To Unfold And Move The Second-Row Passenger Seat Rearward

1. Move the seatback rearward until it locks in place and then continue sliding the seat rearward on its tracks until it locks in place.
2. Push the seat cushion downward to lock it in place.
3. Adjust the seat track position as desired.



Seat In Tip 'n Slide Position

## 50/50 SPLIT THIRD-ROW PASSENGER SEATS WITH FOLD-FLAT FEATURE

### To Fold The Seat

With the second-row passenger seat fully upright, pull the latch release-loop located at the top of the seatback upward, push the seat forward slightly, and release the release-loop. Then, continue to push the seat forward. The head restraints will fold automatically as the seat moves forward.

### To Unfold The Seat

Grasp the assist strap loop on the seatback and pull it toward you to raise the seatback. Continue to raise the seatback until it locks in place. Then, raise the head restraint to lock it in place.

To lock the seatback in a reclined position, pull the latch release-loop located at the top of the seatback upward, allow the seatback to recline, then release the release-loop.



## WARNING!

- Be certain that the seatback is locked securely into position. Otherwise, the seat will not provide the proper stability for child seats and/or passengers. An improperly latched seat could cause you and others to be severely injured or killed.
- Do not allow a passenger to sit in a third row seat without having the head restraint unfolded and locked in place or seatback(s) folded flat. Failure to follow this warning may result in the passengers being severely injured or killed in the event of a collision.
- Do not drive the vehicle with the seat in the Tip 'n Slide position, as it is only intended for entering and exiting the third row seats. Failure to follow this warning may result in you and others being severely injured or killed.
- Be certain that the seatback and seat are locked securely into position. Otherwise, the seat will not provide the proper stability for child seats and/or passengers. An improperly latched seat could cause you or others to be severely injured or killed.

## HEATED SEATS

### Front Heated Seats

The front heated seats control buttons are located within the climate or controls screen of the touchscreen.

- Press the heated seat button  once to turn the HI setting On.
- Press the heated seat button  a second time to turn the LO setting On.
- Press the heated seat button  a third time to turn the heating elements OFF.

If the HI-level setting is selected, the system will automatically switch to LO-level after approximately 60 minutes. The LO-level setting will turn Off automatically after approximately 45 minutes.

### NOTE:

On models that are equipped with Remote Start, this feature can be programmed to come on during a Remote Start through the Uconnect system. Refer to “Uconnect Settings” in “Understanding Your Instrument Panel” in the Owner’s Manual on the DVD.

## WARNING!



- Persons who are unable to feel pain to the skin because of advanced age, chronic illness, diabetes, spinal cord injury, medication, alcohol use, exhaustion or other physical conditions must exercise care when using the seat heater. It may cause burns even at low temperatures, especially if used for long periods of time.
- Do not place anything on the seat that insulates against heat, such as a blanket or cushion. This may cause the seat heater to overheat. Sitting in a seat that has been overheated could cause serious burns due to the increased surface temperature of the seat.

# GETTING STARTED

## HEATED STEERING WHEEL

The steering wheel contains a heating element that heats the steering wheel to one temperature setting.

The heated steering wheel control button is located within the Uconnect system. You can gain access to the control buttons through the climate screen or the controls screen.

- Press the heated steering wheel button  once to turn the heating element ON.
- Press the heated steering wheel button  a second time to turn the heating element OFF.

Once the heated steering wheel has been turned on, it will operate for up to 80 minutes before automatically shutting off. The heated steering wheel can shut off early or may not turn on when the steering wheel is already warm.

### NOTE:

On models that are equipped with Remote Start, this feature can be programmed to come on during a Remote Start through the Uconnect system. Refer to “Uconnect Settings” in “Understanding Your Instrument Panel” in the Owner’s Manual on the DVD.

### WARNING!

- Persons who are unable to feel pain to the skin because of advanced age, chronic illness, diabetes, spinal cord injury, medication, alcohol use, exhaustion, or other physical conditions must exercise care when using the steering wheel heater. It may cause burns even at low temperatures, especially if used for long periods.
- Do not place anything on the steering wheel that insulates against heat, such as a blanket or steering wheel covers of any type and material. This may cause the steering wheel heater to overheat.

## TILT/TELESCOPING STEERING COLUMN

The tilt/telescoping control handle is located below the steering wheel at the end of the steering column.

Push down on the handle to unlock the steering column.

To tilt the steering column, move the steering wheel upward or downward as desired.

To lengthen or shorten the steering column, pull the steering wheel outward or push it inward as desired.

Pull upward on the handle to lock the column firmly in place.



Tilt/Telescoping Control Handle

### WARNING!

Do not adjust the steering wheel while driving. The tilt/telescoping adjustment must be locked while driving. Adjusting the steering wheel while driving or driving without the tilt/telescoping adjustment locked could cause the driver to lose control of the vehicle. Failure to follow this warning may result in you and others being severely injured or killed.

# OPERATING YOUR VEHICLE

## ENGINE BREAK-IN RECOMMENDATIONS

A long break-in period is not required for the engine and drivetrain (transmission and axle) in your vehicle.

Drive moderately during the first 300 miles (500 km). After the initial 60 miles (100 km), speeds up to 50 or 55 mph (80 or 90 km/h) are desirable.

While cruising, brief full-throttle acceleration within the limits of local traffic laws contributes to a good break-in. Wide-open throttle acceleration in low gear can be detrimental and should be avoided.

The engine oil installed in the engine at the factory is a high-quality energy conserving type lubricant. Oil changes should be consistent with anticipated climate conditions under which vehicle operations will occur. Refer to "Maintaining Your Vehicle," for the recommended viscosity and quality grades.

### NOTE:

A new engine may consume some oil during its first few thousand miles (kilometers) of operation. This should be considered a normal part of the break-in and not interpreted as an indication of an engine problem or malfunction.

### CAUTION!

Never use Non-Detergent Oil or Straight Mineral Oil in the engine or damage may result.

## TURN SIGNAL/WIPER/WASHER/HIGH BEAM LEVER



Multifunction Lever

### Turn Signal/Lane Change Assist

Tap the lever up or down once and the turn signal (right or left) will flash three times and automatically turn off.

### Front Wipers

#### Intermittent, Low And High Operation

Rotate the end of the lever to the first detent position for one of five intermittent settings, the second detent for low wiper operation and the third detent for high wiper operation.

#### Washer Operation

Push the end of the lever in to the second detent and release.

#### Mist

Push the end of the lever in to the first detent and release.

#### NOTE:

The mist feature does not activate the washer pump; therefore, no washer fluid will be sprayed on the windshield. The wash function must be activated in order to spray the windshield with washer fluid.

### Rear Wiper

#### Wiper Operation

Rotate the center portion of the lever forward to the first detent for rear wiper operation.



#### Washer Operation

Rotate the center portion of the lever past the first detent to activate the rear washer.

# OPERATING YOUR VEHICLE

## HEADLIGHT SWITCH

### Automatic Headlights/Parking Lights/Headlights

Rotate the headlight switch, located on the instrument panel to the left of the steering wheel, to the first detent  for parking lights and to the second detent for headlights .

With the parking lights or low beam headlights on, push the headlight switch once for fog lights.

Rotate the headlight switch to AUTO for Automatic headlights.

When set to AUTO, the system automatically turns the headlights on or off based on ambient light levels.

### Instrument Panel Dimmer

Rotate the dimmer control to the extreme bottom position to fully dim the instrument panel lights and prevent the interior lights from illuminating when a door is opened.

Rotate the dimmer control up to increase the brightness of the instrument panel when the parking lights or headlights are on.

Rotate the dimmer control up to the next detent position to fully brighten the odometer and radio when the parking lights or headlights are on.

Rotate the dimmer control up to the last detent position to turn on the interior lighting.

If your vehicle is equipped with a touchscreen, the dimming is programmable through the Uconnect system. Refer to “Uconnect Settings” in “Understanding Your Instrument Panel” in the Owner’s Manual on the DVD for further details.

### Door/Map Pocket Lights

Rotate the Door/Map Pocket control up or down to increase or decrease the brightness of the door handle and map pocket lighting when the parking lights or headlights are on.



Headlight Switch

- 1 — Auto
- 2 — Rotate Headlight Switch
- 3 — Push Fog Light
- 4 — Rotate Dimmer



## ELECTRONIC SPEED CONTROL

The Electronic Speed Control switches are located on the steering wheel.

### Cruise ON/OFF

Push the ON/OFF button to activate the Speed Control.

#### NOTE:

CRUISE  will appear on the instrument cluster to indicate the Speed Control is on.

Push the ON/OFF button a second time to turn the system off.

### SET

With the Speed Control on, push and release the SET - button to set a desired speed.

### Accel/Decel

#### To Increase Speed

When the Electronic Speed Control is set, you can increase speed by pushing the RES + button.

The drivers preferred units can be selected through the instrument panel settings if equipped. The speed increment shown is dependant on the chosen speed unit of U.S. (MPH) or Metric (km/h):

#### U.S. Speed (MPH)

- Pushing the RES + button once will result in a 1 MPH increase in set speed. Each subsequent tap of the button results in an increase of 1 MPH.
- If the button is continually pushed, the set speed will continue to increase until the button is released, then the new set speed will be established.

#### Metric Speed (km/h)

- Pushing the RES + button once will result in a 1 km/h increase in set speed. Each subsequent tap of the button results in an increase of 1 km/h.
- If the button is continually pushed, the set speed will continue to increase until the button is released, then the new set speed will be established.



**Electronic Speed Control Switches**

- 1 — Push On/Off
- 2 — Push Resume/Accel
- 3 — Push Set/Decel
- 4 — Push Cancel

# OPERATING YOUR VEHICLE

## To Decrease Speed

When the Electronic Speed Control is set, you can decrease speed by pushing the SET - button.

The drivers preferred units can be selected through the instrument panel settings if equipped. The speed decrement shown is dependant on the chosen speed unit of U.S. (MPH) or Metric (km/h):

### U.S. Speed (MPH)

- Pushing the SET - button once will result in a 1 MPH decrease in set speed. Each subsequent tap of the button results in a decrease of 1 MPH.
- If the button is continually pushed, the set speed will continue to decrease until the button is released, then the new set speed will be established.

### Metric Speed (km/h)

- Pushing the SET - button once will result in a 1 km/h decrease in set speed. Each subsequent tap of the button results in a decrease of 1 km/h.
- If the button is continually pushed, the set speed will continue to decrease until the button is released, then the new set speed will be established.

## Resume

To resume a previously selected set speed in memory, push the RES + button and release.

## Cancel

Push the CANCEL button, or apply the brakes to cancel the set speed and maintain the set speed memory.

Push the ON/OFF button to turn the system off and erase the set speed memory.

### WARNING!

- Leaving the Electronic Speed Control system on when not in use is dangerous. You could accidentally set the system or cause it to go faster than you want. You could lose control and have a collision. Always leave the Electronic Speed Control system off when you are not using it.
- Electronic Speed Control can be dangerous where the system cannot maintain a constant speed. Your vehicle could go too fast for the conditions, and you could lose control. A collision could be the result. Do not use Electronic Speed Control in heavy traffic or on roads that are winding, icy, snow-covered or slippery.

# OPERATING YOUR VEHICLE

## CLIMATE CONTROL

### Uconnect 4.3 Manual Climate Controls

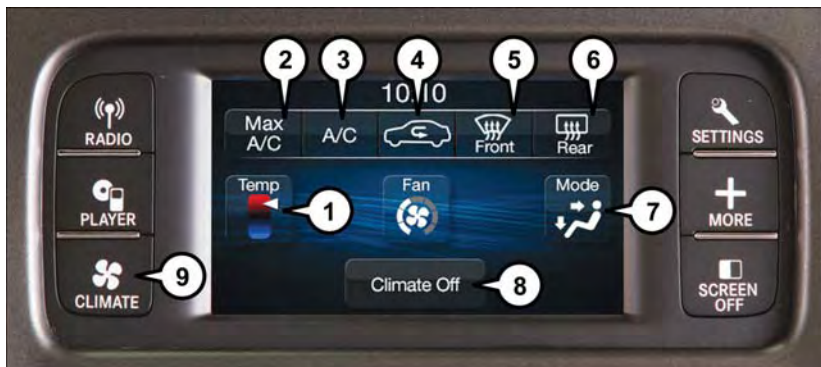

### Uconnect 4.3 Manual Climate Controls

- |                                |                            |
|--------------------------------|----------------------------|
| 1 — Temperature Control Button | 6 — Rear Defrost Button    |
| 2 — MAX A/C Button             | 7 — Mode Control Button    |
| 3 — A/C Button                 | 8 — Climate Off Button     |
| 4 — Air Recirculation Button   | 9 — Climate Control Button |
| 5 — Front Defrost Button       |                            |

# OPERATING YOUR VEHICLE

## Uconnect 8.4 Automatic Climate Controls



### Uconnect 8.4 Automatic Climate Controls

- |                                   |                                   |
|-----------------------------------|-----------------------------------|
| 1 — A/C Button                    | 8 — SYNC Button                   |
| 2 — Air Recirculation Button      | 9 — Increase Blower Speed Button  |
| 3 — AUTO Button                   | 10 — Mode Control Buttons         |
| 4 — Front Defrost Button          | 11 — Decrease Blower Speed Button |
| 5 — Rear Defrost Button           | 12 — OFF Button                   |
| 6 — REAR CLIMATE Button           | 13 — Driver Temperature Control   |
| 7 — Passenger Temperature Control | 14 — MAX A/C Button               |

# OPERATING YOUR VEHICLE

## Climate Control Knobs



### Climate Control Knobs

- |                                   |                                |
|-----------------------------------|--------------------------------|
| 1 — A/C Button                    | 6 — Rotate Blower Control Knob |
| 2 — Air Recirculation Button      | 7 — AUTO Button                |
| 3 — Front Defrost Button          | 8 — Driver Temperature Control |
| 4 — Rear Defrost Button           | 9 — OFF Button                 |
| 5 — Passenger Temperature Control |                                |

- For your convenience the climate controls can be operated by using the buttons on the touchscreen located or the climate control knobs below the Uconnect display.

# OPERATING YOUR VEHICLE

## Automatic Operation — If Equipped

- Push the AUTO button or press the “AUTO” button on the touchscreen.
- Select the desired temperature by pressing the Temperature Controls for the driver or passenger.
- The system will maintain the set temperature automatically.

## SYNC Temperature Button — If Equipped

Press the SYNC button on the touchscreen once to control driver and passenger temperatures simultaneously.

Press the SYNC button on the touchscreen a second time to control the temperatures individually.

## Air Recirculation

- Use recirculation for maximum A/C operation.
- For window defogging, turn the recirculation button off.
- If the Recirculation button on the faceplate is pushed while in the AUTO mode, the indicator light may flash three times to indicate the cabin air is being controlled automatically. The “Recirculation” button on the touchscreen will be greyed out in these conditions.

## Heated Mirrors

The mirrors are heated to melt frost or ice. This feature is activated whenever you turn on the rear window defroster.

## PARKVIEW REAR BACK-UP CAMERA

You can see an on-screen image of the rear of your vehicle whenever the gear selector is put into REVERSE. The ParkView Rear Back-Up Camera image will be displayed on the radio display screen, located on the center stack of the instrument panel.

If the radio display screen appears foggy, clean the camera lens located on the liftgate.

Refer to your Owner's Manual on the DVD for further details.

### **WARNING!**

Drivers must be careful when backing up even when using the ParkView Rear Back Up Camera. Always check carefully behind your vehicle, and be sure to check for pedestrians, animals, other vehicles, obstructions, or blind spots before backing up. You are responsible for the safety of your surroundings and must continue to pay attention while backing up. Failure to do so can result in serious injury or death.

# OPERATING YOUR VEHICLE

## POWER SUNROOF

The power sunroof switch is located on the overhead console.

### Opening Sunroof

#### Express Open

Push the switch rearward and release it within one-half second. The sunroof will fully open and stop automatically.

#### Manual Open

Push and hold the switch rearward to open the sunroof. Any release of the switch will stop the movement, and the sunroof will remain in a partially open position until the switch is pushed again.

### Venting Sunroof

Push and release the button and the sunroof will open to the vent position.

This is called “Express Vent” and will occur regardless of sunroof position. During Express Vent operation, any movement of the switch will stop the sunroof.

### Closing Sunroof

#### Express Closing

Push the switch forward and release it within one-half second. The sunroof will fully close automatically from any position.

#### Manual Closing

Push and hold the switch forward to close the sunroof. Any release of the switch will stop the movement, and the sunroof will remain in a partially closed position until the switch is pushed again.

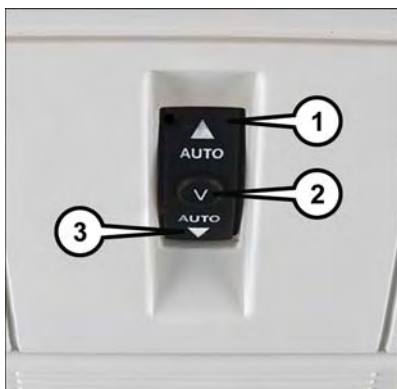

Sunroof Switch

- 1 — Opening Sunroof
- 2 — Venting Sunroof
- 3 — Closing Sunroof



## Pinch Protection Feature

This feature will detect an obstruction in the opening of the sunroof during Express Close operation. If an obstruction in the path of the sunroof is detected, the sunroof will automatically retract. Remove the obstruction if this occurs. Next, push the switch forward and release to Express Close.

### NOTE:

If three consecutive sunroof close attempts result in Pinch Protect reversals, the fourth close attempt will be a Manual Close movement with Pinch Protect disabled.

### WARNING!

- Do not let children play with the sunroof. Never leave children unattended in a vehicle, or with access to an unlocked vehicle. Do not leave the Key Fob in or near the vehicle, and do not leave the ignition of a vehicle equipped with Keyless Enter-N-Go in the ACC or ON/RUN mode. Occupants, particularly unattended children, can become entrapped by the power sunroof while operating the power sunroof switch. Such entrapment may result in serious injury or death.
- In a collision, there is a greater risk of being thrown from a vehicle with an open sunroof. You could also be severely injured or killed. Always fasten your seat belt properly and make sure all passengers are properly secured.
- Do not allow small children to operate the sunroof. Never allow your fingers, other body parts, or any object to project through the sunroof opening. Injury may result.

## WIND BUFFETING

Wind buffeting can be described as a helicopter-type percussion sound. If buffeting occurs with the rear windows open, adjust the front and rear windows together.

If buffeting occurs with the sunroof open, adjust the sunroof opening, or adjust any window. This will minimize buffeting.



## YOUR VEHICLE'S SOUND SYSTEM

1. Uconnect Voice Command Button pg. 75
2. Uconnect Phone Button pg. 68
3. Steering Wheel Audio control (Left – Behind Steering Wheel) pg. 78
4. Steering Wheel Audio control (Right – Behind Steering Wheel) pg. 78
5. Volume Knob/Audio Mute Button
6. CD Eject Button



- 7. Uconnect Radio pg. 51
- 8. Tune/Scroll Knob/Browse/Enter Button
- 9. SD Card Slot (push in to insert/eject) pg. 68
- 10. CD Slot
- 11. Front Power Outlet pg. 85
- 12. Aux Jack (located inside center console) pg. 67
- 13. USB Port (located inside center console) pg. 67

## CYBERSECURITY

Your vehicle may be a connected vehicle and may be equipped with both wired and wireless networks. These networks allow your vehicle to send and receive information. This information allows systems and features in your vehicle to function properly.

Your vehicle may be equipped with certain security features to reduce the risk of unauthorized and unlawful access to vehicle systems and wireless communications. Vehicle software technology continues to evolve over time and FCA US LLC, working with its suppliers, evaluates and takes appropriate steps as needed. Similar to a computer or other devices, your vehicle may require software updates to improve the usability and performance of your systems or to reduce the potential risk of unauthorized and unlawful access to your vehicle systems.

The risk of unauthorized and unlawful access to your vehicle systems may still exist, even if the most recent version of vehicle software (such as Uconnect software) is installed.

### WARNING!

- It is not possible to know or to predict all of the possible outcomes if your vehicle's systems are breached. It may be possible that vehicle systems, including safety related systems, could be impaired or a loss of vehicle control could occur that may result in an accident involving serious injury or death.
- ONLY insert media (e.g., USB, SD card, or CD) into your vehicle if it came from a trusted source. Media of unknown origin could possibly contain malicious software, and if installed in your vehicle, it may increase the possibility for vehicle systems to be breached.
- As always, if you experience unusual vehicle behavior, take your vehicle to your nearest authorized dealer immediately.

### NOTE:

- FCA or your dealer may contact you directly regarding software updates.
- To help further improve vehicle security and minimize the potential risk of a security breach, vehicle owners should:
  - Routinely check [www.driveuconnect.com/software-update](http://www.driveuconnect.com/software-update) to learn about available Uconnect software updates.
  - Only connect and use trusted media devices (e.g. personal mobile phones, USBs, CDs).

Privacy of any wireless and wired communications cannot be assured. Third parties may unlawfully intercept information and private communications without your consent. For further information, refer to "Onboard Diagnostic System (OBD II) Cybersecurity" in "Maintaining Your Vehicle" in your Owner's Manual on the DVD.

## IDENTIFYING YOUR RADIO

### Uconnect 4.3 & 4.3S

- Models 4.3 and 4.3S have a 4.3 inch touchscreen with buttons on the faceplate on each side of it.
- Model 4.3S has all Model 4.3 features, plus SiriusXM Satellite Radio (1-year trial subscription included).
- Model 4.3S is identified by the presence of SAT on the band button, indicating the presence of satellite radio.



Uconnect 4.3 & 4.3S

### Uconnect 8.4 & 8.4N

- Models 8.4 and 8.4N have an 8.4 inch touchscreen.
- Model 8.4N has all Model 8.4 features, plus Garmin Navigation and SiriusXM Travel Link (1-year trial subscription included).
- Model 8.4N is identified by the unique Nav button on the main screen menu bar, located at the bottom of the screen, and the presence of SiriusXM Travel Link within the More menu.



Uconnect 8.4 & 8.4N

## UCONNECT 4.3 & 4.3S AT A GLANCE



Uconnect 4.3 & 4.3S

- 1 — Radio: AM/FM/SIRIUS Satellite Radio (If Equipped)
- 2 — Status Bar
- 3 — Settings: Clock, Display, etc.
- 4 — Screen OFF/ON
- 5 — MORE: Uconnect Phone, Compass, etc.
- 6 — Player: CD, iPod, USB Device or AUX Device

### Displaying The Time

- If the time is not currently displayed at the top of the screen when in Radio mode, push the SETTINGS button, then press “Clock.” Select “Show Time,” then press “On.”

### Setting The Time

- Push the SETTINGS button on the faceplate, then press the “Clock” button on the touchscreen.
- Press the “Time” button on the touchscreen.
- Press the “Up or Down” buttons on the touchscreen to adjust the hours, minutes or AM/PM.

### NOTE:

12hr format and 24hr format can also be set.

- Once the time is set press the “Done” button on the touchscreen to exit the time screen.

## **Audio Settings**

- Push the SETTINGS button on the faceplate on the right side of the unit.
- Then scroll down and press the “Audio” button on the touchscreen to get to the Audio menu.
- The Audio Menu shows the following options for you to customize your audio settings.
  - Equalizer
  - Balance/Fade
  - Speed Adjust Volume
- Press the “Exit” button on the touchscreen to exit from the Audio Menu.

## **Equalizer**

- Press the “Equalizer” button on the touchscreen to adjust the Bass, Mid and Treble. Use the “+” or “-” button on the touchscreen to adjust the equalizer to your desired settings. Press the “Done” button on the touchscreen when done.

## **Balance/Fade**

- Press the “Balance/Fade” button on the touchscreen to adjust the sound from the speakers. Use the “arrow” button on the touchscreen to adjust the sound level from the front and rear or right and left side speakers. Press the center “C” button on the touchscreen to reset the balance and fade to the factory setting. Press the “Done” button on the touchscreen when done.

## **Speed Adjust Volume**

- Press the “Speed Adjust Volume” button on the touchscreen to select between OFF, 1, 2 or 3. This will decrease the radio volume relative to a decrease in vehicle speed. Press the “Done” button on the touchscreen when done.

## UCONNECT 8.4 & 8.4N AT A GLANCE



Uconnect 8.4N

- |                                     |                            |
|-------------------------------------|----------------------------|
| 1 — Status Bar                      | 6 — Climate Control Button |
| 2 — Small Navigation Map (8.4N)     | 7 — Controls Button        |
| 3 — More Settings Button            | 8 — Player Button          |
| 4 — Uconnect Phone Button           | 9 — Radio Button           |
| 5 — Garmin Navigation Button (8.4N) |                            |

### Displaying The Time

- If the time is not currently displayed on the radio or player main page, press the “More” button on the touchscreen and then press the “Settings” button on the touchscreen. In the Settings list, press the “Clock” button on the touchscreen, then press the check box next to Show Time in Status Bar.



### **Setting The Time**

- Model 8.4N synchronizes time automatically via GPS, so should not require any time adjustment. If you do need to set the time manually, follow the instructions below for Model 8.4.
- For Model 8.4, turn the unit on, then press the “Time Display” at the top of the screen. Press “Yes”.
- If the time is not displayed at the top of the screen, press “More” button on the touchscreen and then “Settings” button on the touchscreen. In the Settings screen, press the “Clock” button on the touchscreen, then check or uncheck this option.
- Press “+” or “-” next to Set Time Hours and Set Time Minutes to adjust the time.
- If these features are not available, uncheck the “Sync” with GPS box.
- Press “X” to save your settings and exit out of the Clock Setting screen.

### **Audio Settings**

- Press the “Audio” button on the touchscreen to activate the Audio settings screen to adjust Balance\Fade, Equalizer and Speed Adjusted Volume.
- You can return to the Radio screen by pressing the “X” located at the top right.

### **Balance/Fade**

- Press the “Balance/Fade” button on the touchscreen to Balance audio between the front speakers or fade the audio between the rear and front speakers.
- Pressing the “Front,” “Rear,” “Left” or “Right” buttons on the touchscreen or press and drag the red Speaker Icon to adjust the Balance/Fade.

### **Equalizer**

- Press the “Equalizer” button on the touchscreen to activate the Equalizer screen.
- Press the “+” or “-” buttons on the touchscreen, or by pressing and dragging over the level bar for each of the equalizer bands. The level value, which spans between  $\pm 9$ , is displayed at the bottom of each of the Bands.

### **Speed Adjusted Volume**

- Press the “Speed Adjusted Volume” button on the touchscreen to activate the Speed Adjusted Volume screen. The Speed Adjusted Volume is adjusted by pressing the “+” and “-” buttons or by pressing and dragging over the level bar. This alters the automatic adjustment of the audio volume with variation to vehicle speed.

## RADIO

Models 4.3 & 4.3S



Models 4.3 & 4.3S

1 — Radio Station Presets

2 — View All Presets

3 — Seek Up

4 — Channel/Station Information

5 — Audio Settings

6 — Direct Tune Radio Station

7 — Radio Band

8 — Seek Down

## Models 8.4 & 8.4N

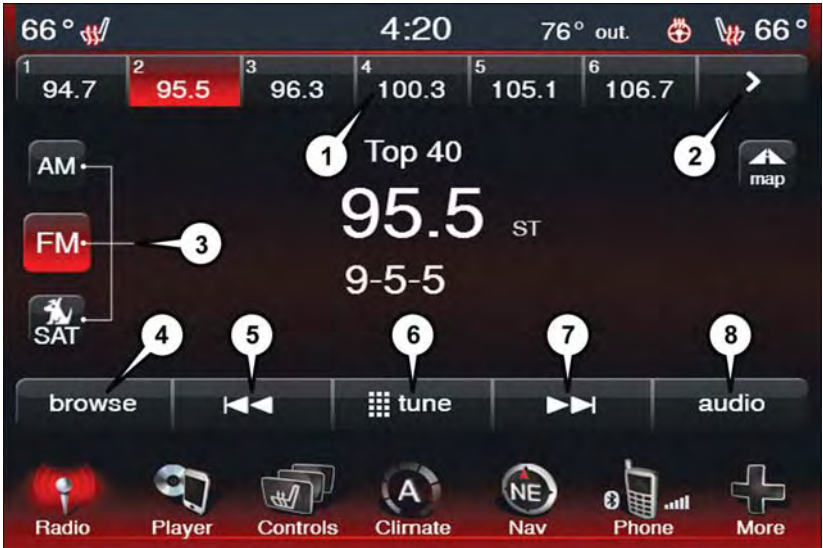

### Uconnect 8.4 Radio

- |                                 |                                    |
|---------------------------------|------------------------------------|
| 1 — Radio Station Presets       | 5 — Seek Down Button               |
| 2 — Toggle Presets 1–6 and 7–12 | 6 — Direct Tune To A Radio Station |
| 3 — Radio Band Buttons          | 7 — Seek Up Button                 |
| 4 — Browse And Manage Stations  | 8 — Audio Settings Button          |

- To access the Radio mode, push the RADIO button on the upper left side of the faceplate (4.3 & 4.3S) or the “Radio” button on the touchscreen at the lower left of the screen (8.4 & 8.4N).
- Unless otherwise noted, the information provided on the operation and functionality of the radios in this section is common to all Uconnect radios.

### Selecting Radio Stations

- Press the “Radio band” button on the touchscreen to cycle through AM, FM or SAT (4.3 & 4.3S) or the desired radio band (AM, FM or SAT) button on the touchscreen (8.4 & 8.4N). SiriusXM Satellite Radio is not available on the 4.3.

## Seek Up/Seek Down

- Press the “Seek arrow” up or down buttons on the touchscreen for less than two seconds to seek through radio stations.
- Press and hold either “Seek arrow” button on the touchscreen for more than two seconds to bypass stations without stopping. The radio will stop at the next listenable station once the arrow button on the touchscreen is released.

## Direct Tune

- Tune directly to a radio station by pressing the “Tune” button on the screen, and entering the desired station number.

## Store Radio Presets Manually

Your radio can store 12 total preset stations. They are shown at the top of your screen. To see all 12 stations, Press the “All” button on the touchscreen (4.3 & 4.3S) or press the “arrow” button on the touchscreen at the top right of the screen to toggle between the six presets (8.4 & 8.4N).

To store a radio preset manually, follow the steps below:

1. Tune to the desired station.
2. Press and hold the desired numbered button on the touchscreen for more than two seconds or until you hear a confirmation beep.

## SIRIUSXM SATELLITE RADIO

- SiriusXM Satellite Radio gives you over 130 channels, including 100% commercial-free music from nearly every genre, plus all your favorite sports, news, talk and entertainment channels – all with crystal clear, coast-to-coast coverage, all in one place and all at your fingertips.
- To access SiriusXM Satellite Radio, press the “Radio band” button on the touchscreen and select the “SAT” button on the touchscreen (4.3S) or press the “SAT” button on the touchscreen on the main Radio screen (8.4 & 8.4N).
- The following describes features that are available when in SiriusXM Satellite Radio mode.
- Unless otherwise noted, the information provided on the operation and functionality of the radios in this section is common to all Uconnect radios.

## Selecting SiriusXM Satellite Channels

### Seek Up/Seek Down

- Press the “Seek arrow” buttons on the touchscreen for less than two seconds to seek through channels in SAT mode.
- Press and hold either “arrow” button on the touchscreen for more than two seconds to bypass channels without stopping. The radio will stop at the next listenable channel once the arrow button on the touchscreen is released.

### Direct Tune

- Tune directly to a SAT channel by pressing the “Tune” button on the screen, and entering the desired station number.

### Info (4.3S Only)

- Provides detailed information about the current SiriusXM Satellite Radio channel.

### More... (4.3S Only)

- Access more menus: Audio, Favorites, Game Zone, and Replay.

### Traffic & Weather (U.S. Residents/8.4 & 8.4N Only)

- Automatically tells you when Traffic & Weather for a favorite city is available, and gives you the option to switch to that channel. Select Traffic & Weather then press “Jump” to activate the feature. After listening to Traffic and Weather, press “Jump” again to return to the previous channel.

### Fav (8.4 & 8.4N Only)

- Activates the favorites menu. You can add up to 50 favorite artists or songs. Just press “Add Fav Artist” or “Add Fav Song” while the song is playing. You will then be alerted any time one of these songs, or works by these artists, is playing on other SiriusXM Satellite Radio channels.

### SiriusXM Parental Controls

- You can skip or hide certain channels from view if you do not want access to them. Push the SETTINGS button on the faceplate (4.3S) or press the “More” button on the touchscreen, then the “Settings” button on the touchscreen (8.4 & 8.4N), next press the “SiriusXM Satellite Radio Setup” button on the touchscreen, then select “Channel Skip.” Press the channel(s) to be skipped (4.3S) or press the box, check-mark, next to the channel you want skipped (8.4 & 8.4N). They will not show up in normal usage.
- SiriusXM Satellite Radio also offers the option to permanently block selected channels. Call 1-888-539-7474 and request the Family Package.

## Browse

- Lets you browse the SiriusXM Satellite Radio channel listing, Favorites, Genres, Game Zone, and Weather channels. Jump setting, and also provides the SiriusXM Satellite Radio channel list. Browse contains many sub-menus.

<b>Browse Sub-Menu</b>	<b>Sub-Menu Description</b>
All	Shows the channel listing.
Genre	Provides a list of all genres, and lets you jump to a channel within the selected genre.
Presets (8.4 & 8.4N Only)	Lets you scroll the list of Preset satellite channels. Press the "Channel", or press "Enter" on the Tune knob, to go to that channel. Press the "Trash can" icon to delete a preset. Your presets are also shown at the top of the main Satellite Radio screen.
Favorites	Lets you manage artists and songs in the Favorites list and configure Alert Settings to let you know when favorite songs or artists are playing on other channels). Also, view a list of channels airing any of your Favorites.
Game Zone	Provides alerts when your favorite sports teams are starting a game which is being aired on other SiriusXM Satellite Radio channels, or when their game score is announced. You can select and manage your Teams list here, and configure alerts.
Traffic/ Weather (4.3S only)	Lets you browse Traffic & Weather information by city.
Jump (8.4 & 8.4N only)	Lets you select your favorite cities for Traffic & Weather information, by selecting Traffic, then Jump feature on the main satellite radio screen.

## Replay

- Lets you replay up to 44 minutes of the content of the current SiriusXM Satellite Radio channel.

<b>Replay Option</b>	<b>Option Description</b>
Play/Pause	Press to Pause content playback. Press "Pause/Play" again to resume playback.
Rewind/RW	Rewinds the channel content in steps of five seconds. Press and hold to rewind continuously, then release to begin playing content at that point.
Fast Forward/FW	Forwards the content, and works similarly to Rewind/RW. However, Fast Forward/FW can only be used when content has been previously rewound.
Replay Time	Displays the amount of time in the upper center of the screen by which your content lags the Live channel.
Live	Resumes playback of Live content at any time while replaying rewound content.

## IPOD/CD/AUX CONTROLS

Models 4.3 &amp; 4.3S

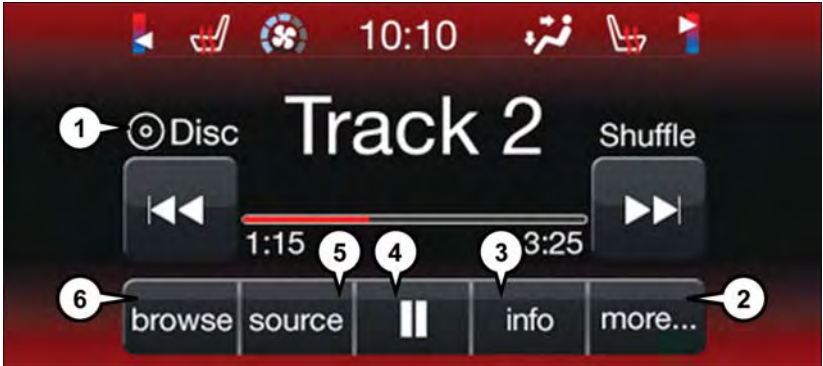

Models 4.3 &amp; 4.3S

- 1 — Music Source
- 2 — More: Audio Settings and Shuffle
- 3 — Current Track Information
- 4 — Play/Pause
- 5 — Source: Disc, iPod, AUX Or Bluetooth
- 6 — Browse Music By: Folder, Artist, Playlist, Song, Album Or Genre

- The iPod/CD/AUX controls are accessed by pushing the PLAYER button on the faceplate to enter the Player main screen, then press the "Source" button on the touchscreen and choose between Disc, AUX, iPod or Bluetooth.

**NOTE:**

Uconnect will usually automatically switch to the appropriate mode when something is first connected or inserted into the system.

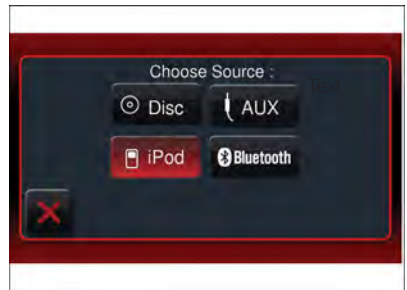

Source 4.3 &amp; 4.3S

## Models 8.4 & 8.4N



### Models 8.4 & 8.4N

- 1 — Music Source: Disc, iPod, SD Card, AUX Or Bluetooth
- 2 — Repeat Track
- 3 — Shuffle Music Tracks
- 4 — Music Track Information
- 5 — Songs In Queue
- 6 — Browse Music By: Folder, Artist, Playlist, Song, Album Or Genre

- The iPod/USB, CD, Audio Jack, SD Card or Bluetooth source is accessed by pressing the “Player” button on the touchscreen to enter the Player main screen, then press the “Source” button on the touchscreen and choose between Disc, Aux, iPod, Bluetooth or SD Card.

#### NOTE:

Uconnect will usually automatically switch to the appropriate mode when something is first connected or inserted into the system.



### Source 8.4 & 8.4N



## GARMIN NAVIGATION

### Garmin Navigation (8.4N Only)

Uconnect 8.4N integrates Garmin's consumer-friendly navigation into your vehicle. Garmin Navigation includes Lane Assist and Junction View, Speed Limit information, and a database with over six million points of interest.

- Press the "Nav" button on the touchscreen in the menu bar to access the Navigation system.

### Changing The Navigation Voice Prompt Volume

1. Program a destination.
2. While traveling on your route, press the upper left area of the map screen where your next turn is displayed.
3. The Navigation system will then repeat the distance to your next turn.
4. While the Navigation system is speaking, use the ON/OFF VOLUME rotary knob to adjust the volume to a comfortable level. Please note the volume setting for Navigation Voice Prompt is different than the audio system.

### Main Navigation Menu



Main Navigation Menu Touchscreen

- |                      |                   |
|----------------------|-------------------|
| 1 — Where To? Button | 4 — Tools Button  |
| 2 — View Map Button  | 5 — Detour Button |
| 3 — Settings Button  | 6 — Stop Button   |

## Acquiring Satellites

- The GPS Satellite strength bars indicate the strength of your satellite reception.
- Acquiring satellite signals can take a few minutes. When at least one of the bars is green, your device has acquired satellite signals. If no signal is found the Navigation system still can operate with internal gyro direction & location based on data provided by the vehicle.
- Dead Reckoning technology uses the speed sensors attached to your vehicle's drive-train, and a gyroscope, to supplement the existing GPS data. The combined data provides accurate positioning for your vehicle in tunnels, indoor parking garages, urban canyons, and any other area where GPS signals can become obstructed.

## Finding Points Of Interest

- From the main Navigation menu press "Where To?" then press "Points of Interest."
- Select a Category, then a subcategory if necessary.
- Select your destination and press "Go."

## Finding A Place By Spelling The Name

- From the Main Navigation Menu press "Where to?" press "Points of Interest" and then press "Spell Name."
- Enter the name of your destination.
- Press "Done."
- Select your destination and press "Go."

## Entering A Destination Address

- From the main Navigation menu, press "Where To?" then press "Address."
- Follow the on-screen prompts to enter the address and press "Go."

## Searching Near Another Location

- From the main Navigation menu, press "Where To?" Press a destination and press "Near."
- Select an option from the available choices.

## Setting Or Changing Your Home Location

- Press the "Nav" button on the touchscreen in the menu bar to access the Navigation system and the Main Navigation menu.
- Press "Where To?" then press "Go Home."
- You may enter your address directly, use your current location as your home address, or choose from recently found locations.
- To edit your Home location (or other saved locations), press "Where To?" from the Main Navigation menu, press "Favorites," then press the location you want to edit. After selecting a location to edit, press "Press for More," then "Edit."

## Go Home

- A Home location must be saved in the system. From the Main Navigation menu, press "Where To?" then press "Go Home."

## Following Your Route



## Following Your Route

- |                           |                               |
|---------------------------|-------------------------------|
| 1 — Distance To Next Turn | 6 — Press And Drag Map        |
| 2 — Current Location      | 7 — Your Location On The Map  |
| 3 — Zoom In Button        | 8 — Estimated Time Of Arrival |
| 4 — Zoom Out Button       | 9 — Return Button             |
| 5 — Current Speed         |                               |

- Your route is marked with a magenta line on the map. If you depart from the original route, your route is recalculated. A speed limit icon could appear as you travel on major roadways.
- Lane Assist helps you decide which lane to be in at upcoming junctions.
- Junction View gives you an expanded view as junctions approach.

**Adding A Via Point**

- To add a stop between your current location and your end destination, you must be navigating a route.
- Press the “back arrow” multiple times to return to the Main Navigation menu.
- Press “Where To?” then search for the via point. Select the via point to add from the search results.
- Press “Go,” then press “Add as a Via Point.”

**Taking A Detour**

- To take a detour you must be navigating a route.
- Press “Detour.”

**NOTE:**

If the route you are currently taking is the only reasonable option, the device might not calculate a detour.

## SIRIUSXM TRAVEL LINK

### SiriusXM Travel Link (8.4N Only)

- SiriusXM Travel Link is only available in the United States.
- SiriusXM Travel Link brings a wealth of useful information into your vehicle and right to your fingertips.
- To access Travel Link, press the “More” button on the touchscreen, then the “Travel Link” button on the touchscreen.

#### NOTE:

SiriusXM Travel Link requires a subscription, sold separately after the 1 year trial subscription included with your vehicle purchase.



SiriusXM Travel Link — 8.4N

<b>1 – Fuel Prices</b>	View detailed price information for fuel stations near your current location.
<b>2 – Movie Listings</b>	View information on movies that are playing at theaters near your current location.
<b>3 – Sports Scores</b>	View scores and upcoming events for all major sports.
<b>4 – SIRIUS</b>	View subscription information.
<b>5 – My Favorites</b>	View and store your favorite location, theater and sport teams for quick access.
<b>6 – Weather</b>	View detailed weather conditions, forecasts and ski/snowboarding conditions at local resorts.

## PLAYING IPOD/USB/MP3 DEVICES

- There are many ways to play music from iPod/MP3 players or USB devices through your vehicles sound system.

### Audio Jack (AUX)

- The Audio Jack, located in the center console, allows a portable device, such as an MP3 player or an iPod, to be plugged into the radio and utilize the vehicles sound system, using a 3.5 mm audio cable, to amplify the source and play through the vehicle speakers.
- Pressing the “Player” button on the touchscreen then choose AUX source will change the mode to auxiliary device if the Audio Jack is connected, allowing the music from your portable device to be heard through the vehicles speakers.
- The functions of the portable device are controlled using the device buttons. The volume may be controlled using the radio or portable device.
- To route the audio cable out of the center console, use the access cut out in the front of the console.

### USB Port

- Connect your iPod or compatible device using a USB cable into the USB Port. The USB Port is contained within the center console. USB Memory sticks with audio files can also be used. Then, audio from the device can be played on the vehicles sound system while providing metadata (artist, track title, album, etc.) information on the radio display.
- When connected, the iPod/compatible USB device can be controlled using the radio or Steering Wheel Audio Controls to play, skip to the next or previous track, browse, and list the contents.
- The iPod battery charges when plugged into the USB port (if supported by the specific device).
- To route the USB/iPod cable out of the center console, use the access cut out in the front of the console.

### NOTE:

- When connecting your iPod device for the first time, the system may take several minutes to read your music, depending on the number of files. For example, the system will take approximately five minutes for every 1,000 songs loaded on the device. Also during the reading process, the Shuffle and Browse functions will be disabled. This process is needed to ensure the full use of your iPod features and only happens the first time it is connected. After the first time, the reading process of your iPod will take considerably less time unless changes are made or new songs are added to the playlist.
- The USB port supports certain Mini, Classic, Nano, Touch, and iPhone devices. The USB port also supports playing music from compatible external USB Mass Storage Class memory devices. Some iPod software versions may not fully support the USB port features. Please visit Apple’s website for iPod software updates.

## SD Card (8.4 and 8.4N Only)

- Play songs stored on an SD card inserted into the SD card slot, located on the radio faceplate.
- Song playback can be controlled using the radio or Steering Wheel Audio Controls to play, skip to the next or previous track, browse, and list the contents.

## Bluetooth Streaming Audio

- If equipped with Uconnect Voice Command, your Bluetooth - equipped iPod devices, cell phones or other media players, may also be able to stream music to your vehicles sound system. Your connected device must be Bluetooth - compatible, and paired with your Uconnect system (see Uconnect Phone for pairing instructions). You can access the music from your connected Bluetooth device by pressing the “Source” button on the touchscreen while in Player mode.

## UCONNECT PHONE

### Uconnect Phone (Bluetooth Hands Free Calling)

- If the Uconnect Phone Button  exists on your steering wheel, then you have the Uconnect Phone features.
- The Uconnect Phone is a voice-activated, hands-free, in-vehicle communications system with Voice Command Capability (see Voice Command section).
- The Uconnect Phone allows you to dial a phone number with your mobile phone using simple voice commands or using touchscreen buttons.
- Refer to the “Understand The Features Of Your Vehicle” section of your vehicle's Owner's Manual on the DVD for further details.

### NOTE:

The Uconnect Phone requires a mobile phone equipped with the Bluetooth Hands-Free Profile, Version 1.0 or higher. For Uconnect customer support: U.S. residents - visit [UconnectPhone.com](http://UconnectPhone.com) or call 1-877-855-8400. Canadian Residents - call 1-800-465-2001 (English) or 1-800-387-9983 (French).

### Pairing A Phone

- To use the Uconnect Phone feature, you must first pair your Bluetooth phone with the Uconnect system.

## Start Pairing Procedure On The Radio

- **Models 4.3, 4.3S:** Push the MORE button on the faceplate, then press the “Phone” button on the touchscreen. Next, press the “Settings” button on the touchscreen and then “Add Device.”

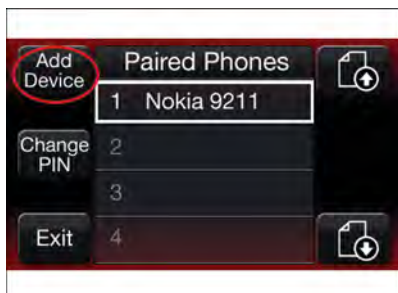

Models 4.3 & 4.3S

- **Models 8.4, 8.4N:** Press the “Phone” button on the touchscreen and then the “Settings” button on the touchscreen. Next, press “Add Device.”
- Uconnect Phone will display an “In progress” screen while the system is connecting.



Models 8.4 & 8.4N

## Start Pairing Procedure On Mobile Phone

- Search for available devices on your Bluetooth enabled mobile phone. This is usually within Settings or Options under “Bluetooth.” See your mobile phone’s manual for details.
- When your phone finds the system, select “Uconnect” as the paired device.

## Complete The Pairing Procedure

- When prompted on the phone, enter the 4-digit PIN number shown on the Uconnect Screen.
- If your phone asks you to accept a connection request from Uconnect, select “Yes.” If available, check the box telling it not to ask again – that way your phone will automatically connect each time you start the vehicle.

### NOTE:

Refer to [UconnectPhone.com](http://UconnectPhone.com) website for additional information on phone pairing and for a list of compatible phones.



Models 4.3 & 4.3S



Models 8.4 & 8.4N

- 1 — Name That Appears On Mobile Phone
- 2 — 4-Digit PIN To Be Entered On Mobile Phone



## Select The Mobile Phone's Priority Level

- When the pairing process has successfully completed, the system will prompt you to choose whether or not this is your favorite phone. Selecting “Yes” will make this phone the highest priority. This phone will take precedence over other paired phones within range. Only one phone can be connected at a time.
- You are now ready to make hands-free calls. Push the Uconnect Phone button on your steering wheel to begin.



Phone Menu Screen — Models 4.3 & 4.3S

- |                          |                                       |
|--------------------------|---------------------------------------|
| 1 — Redial Last Number   | 8 — Conference Call                   |
| 2 — Phone Signal         | 9 — Direct Dial                       |
| 3 — Current Phone        | 10 — Recent Call List                 |
| 4 — Phone Battery Level  | 11 — Browse Phone Book (Contains 911) |
| 5 — Mute Microphone      | 12 — End Call                         |
| 6 — Transfer Radio/Phone |                                       |
| 7 — Manage Paired Phones |                                       |



Phone Menu Screen — Models 8.4 & 8.4N

- |                                |                                       |
|--------------------------------|---------------------------------------|
| 1 — Favorite Phonebook Entries | 9 — SMS (text messaging)              |
| 2 — Phone Battery Level        | 10 — Direct Dial                      |
| 3 — Current Phone              | 11 — Recent Call List                 |
| 4 — Phone Signal               | 12 — Browse Phone Book (Contains 911) |
| 5 — Mute Microphone            | 13 — End Call                         |
| 6 — Transfer Radio/Phone       | 14 — Hold/Redial Last Number          |
| 7 — Conference Call            |                                       |
| 8 — Manage Paired Phones       |                                       |

## Making A Phone Call



To begin a phone call using Uconnect Voice Command:

- Push the Uconnect Phone button .
- After the BEEP, say “dial” then the number (or “call” then the name as listed in your phone; see Phonebook).

### NOTE:

You can also initiate a call by using the touchscreen on the Phone main screen.

### Receiving A Call — Accept (And End)

- When an incoming call rings/is announced on Uconnect, push the Phone button .
- To end a call, push the Phone button .

### Mute (Or Unmute) Microphone During Call

- During a call, press the “mute” button on the touchscreen to mute and unmute the call.

### Transfer Ongoing Call Between Handset And Vehicle

During an on-going call, press the “Transfer” button on the touchscreen to transfer an on-going call between handset and vehicle.

### Common Phone Commands (Examples)

- “Call John Smith”
- “Call John Smith mobile”
- “Dial 1 248 555 1212”
- “Call Emergency”
- “Call Towing Assistance”
- “Redial”

### Phonebook

- Uconnect radios will automatically download your phonebook from your paired phone, if this feature is supported by your phone. Entries are updated each time that the phone is connected. If your phone book entries do not appear, check the settings on your phone. Some phones require you to enable this feature manually.
- Your phonebook can be browsed on your radio screen, but editing can only be done on your phone. To browse, press the “Phone” button on the touchscreen, then the “Phonebook” button on the touchscreen.
- Favorite phonebook entries can be saved as Favorites for quicker access. Favorites are shown at the top of your main phone screen.



### Voice Command Tips (8.4 And 8.4N Only)

- Using complete names (i.e; Call John Doe vs. Call John) will result in greater system accuracy.
- You can “chain” commands together for faster results. Say “Call John Doe mobile,” for example.
- If you are listening to available voice command options, you do not have to listen to the entire list. When you hear the command that you need, press the  button on the steering wheel, wait for the beep and say your command.

## Changing The Volume

- Start a dialogue by pressing the Phone button  , then say a command for example - "Help."
- Use the radio ON/OFF VOLUME rotary knob to adjust the volume to a comfortable level while the Uconnect system is speaking. Please note the volume setting for Uconnect is different than the audio system.

### NOTE:

To access help, press the Uconnect Phone  button on the steering wheel and say "help." Press the display or push either  or  button and say "cancel" to cancel the help session.

## Voice Text Reply

- Uconnect Phone can read or send new text messages on your mobile phone.
- Your mobile phone must support Voice Text Reply over Bluetooth to use this feature. If the Uconnect Phone determines your mobile phone is not compatible with Voice Text Reply messaging over Bluetooth, the "Messaging" button will be greyed out and the feature will not be available for use.



### NOTE:

- For mobile phone compatibility and pairing instructions, please visit [UconnectPhone.com](http://UconnectPhone.com).
- Uconnect Phone Voice Text Reply is only available when the vehicle is not moving.

## WARNING!

- Any voice commanded system should be used only in safe driving conditions following applicable laws regarding phone use. Your attention should be focused on safely operating the vehicle. Failure to do so may result in a collision causing you and others to be severely injured or killed.
- In an emergency, to use Uconnect Phone, your mobile phone must be:
  - turned on
  - paired to Uconnect Phone
  - have network coverage

## UCONNECT VOICE COMMAND (8.4 & 8.4N ONLY)

- If the Uconnect Voice Command  button exists on your steering wheel, then you have the Voice Command feature.
- The Voice Command feature lets you keep your hands on the steering wheel, and your eyes on the road.
- When you press the Voice Command button  located on the radio faceplate or steering wheel, you will hear a beep. The beep is your signal to give a command. If you do not know what commands to say, you can say "help" and the system will provide options to you. If you ever wish to interrupt the system while it lists options, press the Voice Command button , listen for the BEEP, and say your command.
- You can "chain" commands together for faster results. Say "Play the artist Scott Joplin", for example.

### Changing The Volume

- Start a dialogue by pressing the Voice Command button , then say a command (for example, "help").
- Use the radio ON/OFF VOLUME rotary knob to adjust the volume to a comfortable level while the Voice Command system is speaking. The volume setting for Voice Command is different than the audio system.
- Refer to the "Understand The Features Of Your Vehicle" section of your vehicle's Owner's Manual on the DVD for further details.

### Common Voice Commands (Examples)

<b>Switch Modes</b>	"FM" "Satellite" "AM" "Change Source to iPod" "Change Source to SD Card"
<b>Radio (FM, AM)</b>	"95.5" "95.5 FM" "Go to preset 5"
<b>Player</b>	"Play Album 'Greatest Hits" "Play Artist 'Scott Joplin" "Play Genre 'Rock" "Play Song 'Maple Leaf Rag"
<b>SiriusXM Satellite Radio</b>	"39" "Foxxhole"

<b>SiriusXM Travel Link</b>	"Show fuel prices" "Show movie listings" "Show current weather" "Show extended weather" "Show Travel Link favorites" "Show NFL headlines" "Show NBA rankings" "Show NFL schedules" "Show NBA scores"
<b>Navigation</b>	"Navigate to (Address)" "Navigate to (Point of Interest)"

**NOTE:**

For the shortened SiriusXM Satellite Radio mode commands to be recognized you must be in that mode. For example, if you are in SiriusXM Satellite Radio mode you can say "39," but if you are not in SiriusXM mode, you would need to say "Tune to Satellite Channel 39."

### Common Navigation Voice Commands

- To access the navigation voice commands, press the Uconnect Voice Command  button while in any mode and say "Navigation."
- Once in the Navigation feature, you can simply **Say What You See** on the touchscreen to give a navigation voice command.
- Locating an address can be given as a **one shot entry**. For example, after saying "Find Address" and the system is ready, you can say the entire address in one command, "1234 1st Street, Any Town, Michigan." If you are searching for a particular address or Point Of Interest, the available voice commands depend on what is displayed on the touchscreen.
- When the Voice Command system is ready to be given a command, the green indicator is visible in the right corner of the touchscreen.

The following chart lists the navigation voice commands that may be available.

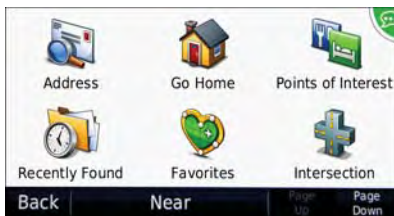

Voice Command "Ready"

Navigation Voice Commands:	
"Where To?" (Main Menu command) "View Map" (Main Menu command) "Repeat guidance" "Cancel Route" "De- tour" (During a Route Guidance) "Where Am I?" "Find Address" "Go Home" "Find Place by Category" "Find Place by Name" "Find Recently Found" "Find Favorite" "Find City" "Find Nearest Restaurant" "Find Nearest Fuel"	"Find Nearest Transit" "Find Nearest Lodging" "Find Nearest Shopping" "Find Nearest Bank" "Find Nearest Parking" "Find Nearest Entertainment" "Find Nearest Recreation" "Find Nearest Attractions" "Find Nearest Hospitals" "Find Nearest Community" "Find Nearest Auto Services" "Find Nearest Airport" "Find Nearest Police Stations" "Find Nearest Fire Stations" "Find Nearest Auto Dealers"

## WARNING!

Any voice commanded system should be used only in safe driving conditions following applicable laws regarding phone use. Your attention should be focused on safely operating the vehicle. Failure to do so may result in a collision causing you and others to be severely injured or killed.

## VIDEO ENTERTAINMENT SYSTEM (VES)

### System Operation

- The screen is located on the headliner behind the front seat. To lower the screen, press the release button located in the rear of the overhead console.
- The system may be controlled by the front seat occupants using the touchscreen radio, or by the rear seat occupants using the remote control.
- The video screen displays information in a split-screen format. The left side of the screen is referred to as Channel 1 and the right side of the screen is referred to as Channel 2. All modes except video modes are displayed in a split-screen format.
- To use the headphones, press the power button located on the right ear cup. Select the channel on the headphones (1 or 2) that corresponds to the channel selected on the VES screen.

## Operation Of The Remote

The remote control operates similarly to any DVD remote you have used before and allows the rear seat passengers to change stations, tracks, discs and audio/video modes and is designed to control either channel by using the selector switch located on the right side of the remote.

- Select an audio channel (Rear 1 for driver's side rear screen and Rear 2 for passenger's side rear screen), then press the "source" button and using the up and down arrows, highlight disc from the menu and press the "OK" button.
- Press the popup/menu button to navigate the disc menu and options.

Pressing the MODE button causes the Mode Selection menu to appear on the VES screen. Use the remote control arrow buttons to scroll through the available modes, then press ENTER to select the desired mode.

Pressing the power button will turn the VES system ON/OFF.

## Auxiliary Audio/Video Input Jacks

- The Aux jacks are located on the rear of the center console.
- Connect the video game or other external media devices to the AUX jacks following the color coding for VES jacks.
- Using either the touchscreen radio or remote control, select AUX from the Rear VES Control or Mode Selection screen.
- Refer to your vehicle's Owner's Manual on the DVD for further details.

## STEERING WHEEL AUDIO CONTROLS

The steering wheel audio controls are located on the rear surface of the steering wheel.

### Right Switch

- Push the switch up or down to increase or decrease the volume.
- Push the button in the center to change modes AM/FM/CD/SAT.

### Left Switch

- Push the switch up or down to search for the next listenable station.
- Push the button in the center to select the next preset station.



Steering Wheel Audio Controls



## ELECTRONIC VEHICLE INFORMATION CENTER (EVIC)

The EVIC features a driver interactive display that is located in the instrument cluster. Pushing the controls on the left side of the steering wheel allows the driver to select vehicle information and Personal Settings. Refer to “Programmable Features” located in this guide for further information.

- Push the **UP**  $\triangle$  arrow button to scroll upward through the main menus (Fuel Economy, Vehicle Speed, Trip Info, Vehicle Info, Messages, Units, System Set-Up, Turn Menu Off) and sub menus.
- Push the **DOWN**  $\nabla$  arrow button to scroll downward through the main menus and sub menus.
- Push the **RIGHT**  $\triangleright$  arrow button for access to main menus, sub menus or to select a personal setting in the setup menu.
- Push the **BACK** button to scroll back to a previous menu or sub menu.



EVIC Controls

### Compass Calibration

This compass is self-calibrating, which eliminates the need to set the compass manually. When the vehicle is new, the compass may appear erratic, and the EVIC will display “CAL” until the compass is calibrated.

You may also calibrate the compass by completing one or more 360 degree turns (in an area free from large metal or metallic objects) until the “CAL” message displayed in the EVIC turns off. The compass will now function normally.

## PROGRAMMABLE FEATURES

### Electronic Vehicle Information Center (EVIC) — If Equipped

- The EVIC can be used to view or change the following settings. Push the **UP**  $\triangle$  or **DOWN**  $\nabla$  arrow button until System Setup displays, then push the **RIGHT**  $\triangleright$  arrow button. Scroll through the settings using the **UP**  $\triangle$  or **DOWN**  $\nabla$  arrow button. Push the **RIGHT**  $\triangleright$  arrow button to change the setting. Push the **BACK** button to scroll back to a previous menu or sub menu.
- Fuel Economy
  - Average Fuel Economy
  - Distance To Empty (DTE)
  - Miles Per Gallon (MPG)
- Vehicle Speed
- Messages
- Trip Info
  - Trip A
  - Trip B
  - Elapsed Time
- Tire PSI
- Vehicle Info (Customer Information Features)

### Uconnect 4.3 Customer Programmable Features

- The Uconnect 4.3 system allows you to access Customer Programmable feature settings such as Display, Clock, Safety/Assistance, Lights, Doors & Locks, Heated Seats, Engine Off Operation, Compass Settings, Audio, Phone/Bluetooth and SIRIUS Setup through buttons on the faceplate and buttons on the touchscreen.
- Press the “Settings” button on the right side of the unit to access the Settings screen, use the “Page Up/Down” buttons on the touchscreen to scroll through the following settings. The following feature settings are available:
  - Display
  - Clock
  - Safety/Assistance
  - Lights
  - Doors & Locks
  - Auto On Comfort & Remote Start
  - Engine Off Options
  - Audio
  - Phone/Bluetooth
  - SIRIUS Setup

## Uconnect 8.4 Customer Programmable Features

- The Uconnect 8.4 system allows you to access Customer Programmable feature settings such as Display, Clock, Safety/Assistance, Lights, Doors & Locks, Heated Seats, Engine Off Operation, Compass Settings, Audio, Phone/Bluetooth and SIRIUS Setup through buttons on the touchscreen.
- Press the “More” button on the bottom of the touchscreen, then press the “Settings” button on the faceplate to access the Settings screen. When making a selection, scroll up or down until the preferred setting is highlighted, then press and release the preferred setting until a check-mark appears next to the setting, showing that setting has been selected. The following feature settings are available:
  - Display
  - Clock
  - Safety/Assistance
  - Lights
  - Doors & Locks
  - Auto On Comfort & Remote Start
  - Engine Off Options
  - Audio
  - Phone/Bluetooth
  - SIRIUS Setup

## UNIVERSAL GARAGE DOOR OPENER (HOMELINK)

- HomeLink replaces up to three hand-held transmitters that operate devices such as garage door openers, motorized gates, lighting or home security systems. The HomeLink unit is powered by your vehicle's 12 Volt battery.
- The HomeLink buttons that are located in the overhead console or sunvisor designate the three different HomeLink channels.
- The HomeLink indicator is located above the center button.

### Before You Begin Programming HomeLink

Ensure that your vehicle is parked outside of the garage before you begin programming.

For efficient programming and accurate transmission of the radio-frequency signal, it is recommended that a new battery be placed in the hand-held transmitter of the device that is being programmed to the HomeLink system.

To erase the channels, place the ignition switch into the ON/RUN position, then push and hold the two outside HomeLink buttons (I and III) for up to 20 seconds or until the red indicator flashes.



Universal Garage Door Opener (HomeLink) Buttons

**NOTE:**

Erasing all channels should only be performed when programming HomeLink for the first time. Do not erase channels when programming additional buttons.

If you have any problems, or require assistance, please call toll-free 1-800-355-3515 or, on the Internet at HomeLink.com for information or assistance.

## Programming A Rolling Code

**NOTE:**

For programming Garage Door Openers that were manufactured after 1995. These Garage Door Openers can be identified by the “LEARN” or “TRAIN” button located where the hanging antenna is attached to the Garage Door Opener. It is NOT the button that is normally used to open and close the door. The name and color of the button may vary by manufacturer.

1. Place the ignition switch into the ON/RUN position.
2. Place the hand-held transmitter 1 to 3 inches (3 to 8 cm) away from the HomeLink button you wish to program while keeping the HomeLink indicator light in view.
3. Push and hold the HomeLink button you want to program while you push and hold the hand-held transmitter button.
4. Continue to hold both buttons and observe the indicator light. The HomeLink indicator will flash slowly and then rapidly after HomeLink has received the frequency signal from the hand-held transmitter. Release both buttons after the indicator light changes from slow to rapid.
5. At the garage door opener motor (in the garage), locate the “LEARN” or “TRAINING” button. This can usually be found where the hanging antenna wire is attached to the garage door opener motor. Firmly push and release the “LEARN” or “TRAINING” button.

**NOTE:**

You have 30 seconds in which to initiate the next step after the LEARN button has been pushed.

6. Return to the vehicle and push the programmed HomeLink button twice (holding the button for two seconds each time). If the device is plugged in and activates, programming is complete.

**NOTE:**

If the device does not activate, push the button a third time (for two seconds) to complete the training.

7. To program the remaining two HomeLink buttons, repeat each step for each remaining button. DO NOT erase the channels.

## Programming A Non-Rolling Code

### NOTE:

For programming Garage Door Openers manufactured before 1995.

1. Turn the ignition switch to the ON/RUN position.
2. Place the hand-held transmitter 1 to 3 inches (3 to 8 cm) away from the HomeLink button you wish to program while keeping the HomeLink indicator light in view.
3. Push and hold the HomeLink button you want to program while you push and hold the hand-held transmitter button.
4. Continue to hold both buttons and observe the indicator light. The HomeLink indicator will flash slowly and then rapidly after HomeLink has received the frequency signal from the hand-held transmitter. Release both buttons after the indicator light changes from slow to rapid.
5. Push and hold the programmed HomeLink button and observe the indicator light. If the indicator light stays on constantly, programming is complete and the garage door (or device) should activate when the HomeLink button is pushed.
6. To program the two remaining HomeLink buttons, repeat each step for each remaining button. DO NOT erase the channels.

## Using HomeLink

To operate, push and release the programmed HomeLink button. Activation will now occur for the programmed device (e.g., garage door opener, gate operator, security system, entry door lock, home/office lighting, etc.). The hand-held transmitter of the device may also be used at any time.

### **WARNING!**

- Your motorized door or gate will open and close while you are programming the universal transceiver. Do not program the transceiver if people or pets are in the path of the door or gate.
- Do not run your vehicle in a closed garage or confined area while programming the transceiver. Exhaust gas from your vehicle contains Carbon Monoxide (CO) which is odorless and colorless. Carbon Monoxide is poisonous when inhaled and can cause you and others to be severely injured or killed.

## POWER INVERTER

- There is a 115 Volt, 150 Watt power inverter outlet located on the back of the center console. This outlet can power cellular phones, electronics and other low power devices requiring power up to 150 Watts.

### Uconnect 4.3 System

- Push the MORE button on the faceplate (located next to the Uconnect screen).
- Press the “Outlet” button on the touchscreen to turn the power inverter On or Off.

### Uconnect 8.4 System

- Press the “Controls” button on the touchscreen (located at the bottom of the Uconnect screen).
- Press the “Outlet” button on the touchscreen to turn the power inverter On or Off.



Power Inverter

### NOTE:

The power inverter is designed with built-in overload protection. If the power rating of 150 Watts is exceeded, the power inverter will automatically shut down. Once the electrical device has been removed from the outlet, the inverter should automatically reset. If the power rating exceeds approximately 170 Watts, the power inverter may have to be reset manually. To reset the inverter manually, unplug the device and plug it in again. To avoid overloading the circuit, check the power ratings on electrical devices prior to using the inverter.

### WARNING!

- To Avoid Serious Injury or Death DO NOT:
  - use a three-prong adaptor
  - insert any objects into the receptacles
  - touch with wet hands

Close the lid when not in use. If this outlet is mishandled, it may cause an electric shock and failure.

## POWER OUTLETS

- There is a 12 Volt power outlet located in the front storage bin below the radio. This outlet has power available when the ignition switch is in the ON position.
- A second 12 Volt power outlet is located inside the center console. This outlet has power available when the ignition switch is in the LOCK, ON, or ACC position.
- A third 12 Volt power outlet is located on the back of the center console. This outlet has power available when the ignition switch is in the LOCK, ON or ACC position.
- A fourth fused 12 Volt power outlet is located on the left quarter trim panel in the cargo area. This outlet has power available when the ignition switch is in the ON or ACC position.



**Front Power Outlet**

## NOTE:

- Do not exceed the maximum power of 160 Watts (13 Amps) at 12 Volts. If the 160 Watt (13 Amp) power rating is exceeded, the fuse protecting the system will need to be replaced.
- Power outlets are designed for accessory plugs only. Do not insert any other object in the power outlet as this will damage the outlet and blow the fuse. Improper use of the power outlet can cause damage not covered by your New Vehicle Limited Warranty.

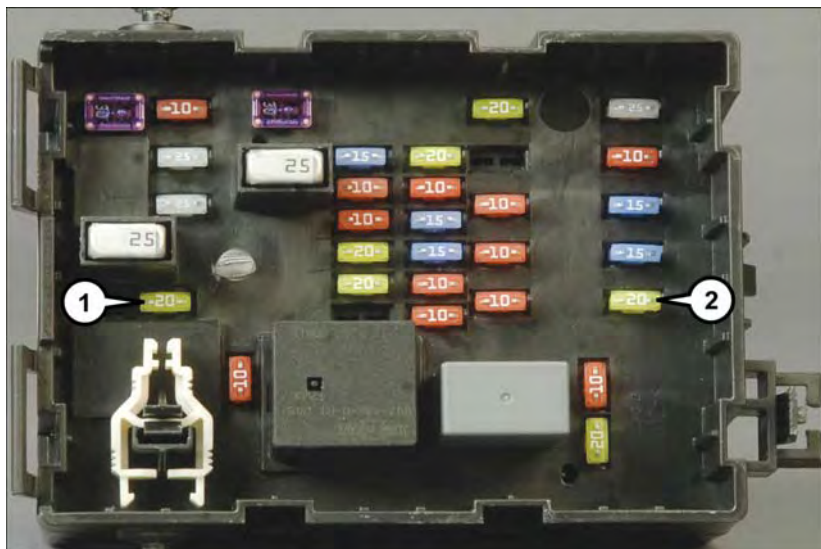

**Power Outlet Fuses**

- 1 — F103 20 Amp Yellow — Power Outlet Console Bin & Power Outlet Console Rear  
2 — F102 20 Amp Yellow — Cigar Lighter Instrument Panel & Power Outlet Left Rear Cargo Area
-



## TRAILER TOWING WEIGHTS (MAXIMUM TRAILER WEIGHT RATINGS)

Engine/Transmission	GCWR (Gross Combined Wt. Rating)	Frontal Area	Max. GTW (Gross Trailer Wt.)	Max. Tongue Wt.
2.4L/Automatic	6,000 lbs (2,722 kg)	22 sq ft (2.0 sq m)	1,000 lbs (454 kg) which includes up to 5 persons & Luggage	100 lbs (45 kg)
	7,300 lbs (3,311 kg)	32 sq ft (3.0 sq m)	2,500 lbs (1,134 kg) which includes 1 to 2 persons & Luggage	200 lbs (91 kg)
3.6L/Automatic	7,300 lbs (3,311 kg)	32 sq ft (3.0 sq m)	2,000 lbs (907 kg) which includes 3 to 4 persons & Luggage	150 lbs (68 kg)
	7,300 lbs (3,311 kg)	32 sq ft (3.0 sq m)	1,500 lbs (680 kg) which includes 5 to 7 persons & Luggage	100 lbs (45 kg) * Except for AWD models

### NOTE:

- The trailer tongue weight must be considered as part of the combined weight of occupants and cargo, and should never exceed the weight referenced on the Tire and Loading Information placard.
- \* For All Wheel Drive (AWD) models carrying 5 to 7 persons and luggage will exceed the rear Gross Axle Weight Rating (GAWR) and therefore should not be attempted.

## RECREATIONAL TOWING (BEHIND MOTORHOME, ETC.)

### Towing This Vehicle Behind Another Vehicle

Towing Condition	Wheel OFF the Ground	FWD Models	AWD Models
Flat Tow	NONE	<b>NOT ALLOWED</b>	<b>NOT ALLOWED</b>
Dolly Tow	Front	OK	<b>NOT ALLOWED</b>
	Rear	<b>NOT ALLOWED</b>	<b>NOT ALLOWED</b>
On Trailer	ALL	OK	OK

NOTE: When recreational towing your vehicle, always follow applicable state and provincial laws. Contact state and provincial Highway Safety offices for additional details.

#### Recreational Towing — Front-Wheel Drive (FWD) Models

Recreational towing is allowed **ONLY** if the front wheels are **OFF** the ground. This may be accomplished using a tow dolly or vehicle trailer. If using a tow dolly, follow this procedure:

1. Properly secure the dolly to the tow vehicle, following the dolly manufacturer's instructions.
2. Drive the front wheels onto the tow dolly.
3. Firmly apply the parking brake. Place the transmission in PARK.
4. Properly secure the front wheels to the dolly, following the dolly manufacturer's instructions.
5. Release the parking brake.

#### CAUTION!

- DO NOT flat tow this vehicle. Damage to the drivetrain will result. If this vehicle requires towing, make sure the drive wheels are OFF the ground.
- Towing this vehicle in violation of the above requirements can cause severe transmission damage. Damage from improper towing is not covered under the New Vehicle Limited Warranty.

#### Recreational Towing — All-Wheel Drive (AWD) Models

Recreational towing (with all four wheels on the ground, or using a towing dolly) is **NOT ALLOWED**. The only acceptable method for towing this vehicle (behind another vehicle) is on a vehicle trailer with all four wheels **OFF** the ground.

#### CAUTION!

Towing this vehicle with **ANY** of its wheels on the ground can cause severe transmission and/or power transfer unit damage. Damage from improper towing is not covered under the New Vehicle Limited Warranty.

# WHAT TO DO IN EMERGENCIES

## ROADSIDE ASSISTANCE

Dial toll-free 1-800-521-2779 for U.S. Residents or 1-800-363-4869 for Canadian Residents.

- Provide your name, vehicle identification number, license plate number, and your location, including the telephone number from which you are calling.
- Briefly describe the nature of the problem and answer a few simple questions.
- You will be given the name of the service provider and an estimated time of arrival. If you feel you are in an “unsafe situation”, please let us know. With your consent, we will contact local police or safety authorities.

## INSTRUMENT CLUSTER WARNING LIGHTS

### – Low Fuel Warning Light

This warning light indicates when the fuel level reaches approximately 1.5 gal (5.8 L). This light will turn on and a single chime will sound.

### – Charging System Light

This light shows the status of the electrical charging system. If the charging system light remains on, it means that the vehicle is experiencing a problem with the charging system.

We recommend you do not continue driving if the charging system light is on. Have the vehicle serviced immediately.

### – Oil Pressure Warning Light

This light indicates low engine oil pressure. If the light turns on while driving, stop the vehicle and shut off the engine as soon as possible. A chime will sound for four minutes when this light turns on.

We recommend you do not operate the vehicle or engine damage will occur. Have the vehicle serviced immediately.

### – Anti-Lock Brake (ABS) Light

This light monitors the Anti-Lock Brake System (ABS). The light will turn on when the ignition switch is turned to the ON/RUN position and may stay on for as long as four seconds.

If the ABS light remains on or turns on while driving, it indicates that the Anti-Lock portion of the brake system is not functioning and that service is required. However, the conventional brake system will continue to operate normally if the BRAKE warning light is not on.

If the ABS light is on, the brake system should be serviced as soon as possible to restore the benefits of Anti-Lock brakes. If the ABS light does not turn on when the ignition switch is turned to the ON/RUN position, have the light inspected by an authorized dealer.

# WHAT TO DO IN EMERGENCIES

## – Air Bag Warning Light

This light will turn on for four to eight seconds as a bulb check when the ignition switch is first turned to the ON/RUN position. If the light is either not on during starting, stays on, or turns on while driving, have the system inspected at an authorized dealer as soon as possible. Refer to “Occupant Restraints” in “Things To Know Before Starting Your Vehicle” in your Owner’s Manual on the DVD for further information.

### **NOTE:**

The Air Bag System is designed to be maintenance free.

## – Electronic Throttle Control (ETC) Light

This light informs you of a problem with the Electronic Throttle Control (ETC) system.

If a problem is detected, the light will come on while the engine is running. Cycle the ignition when the vehicle has completely stopped and the shift lever is placed in the PARK position; the light should turn off.

If the light remains lit with the engine running, your vehicle will usually be drivable; however, see an authorized service center immediately. If the light is flashing when the engine is running, immediate service is required and you may experience reduced performance, an elevated/rough idle or engine stall and your vehicle may require towing.

## – Tire Pressure Monitoring System (TPMS) Light

Each tire, including the spare (if provided), should be checked monthly, when cold and inflated to the inflation pressure recommended by the vehicle manufacturer on the vehicle placard or tire inflation pressure label. (If your vehicle has tires of a different size than the size indicated on the vehicle placard or tire inflation pressure label, you should determine the proper tire inflation pressure for those tires.)

As an added safety feature, your vehicle has been equipped with a Tire Pressure Monitoring System (TPMS) which display in the Electronic Vehicle Information Center (EVIC) or Driver Information Display (DID) when one or more of your tires is significantly under-inflated. Accordingly, when the low tire pressure EVIC or DID display illuminates, you should stop and check your tires as soon as possible, and inflate them to the proper pressure. Driving on a significantly under-inflated tire causes the tire to overheat and can lead to tire failure. Under-inflation also reduces fuel efficiency and tire tread life, and may affect the vehicle’s handling and stopping ability.

**IF THE LIGHT STARTS FLASHING INDICATING A LOW TIRE PRESSURE, ADJUST THE AIR PRESSURE IN THE LOW TIRE TO THE AIR PRESSURE SHOWN ON THE VEHICLE PLACARD OR TIRE INFLATION PRESSURE LABEL LOCATED ON THE DRIVER’S DOOR.**

### **NOTE:**

**After inflation, the vehicle may need to be driven for 20 minutes before the flashing light will turn off.**

# WHAT TO DO IN EMERGENCIES

Please note that the TPMS is not a substitute for proper tire maintenance, and it is the driver's responsibility to maintain correct tire pressure, even if under-inflation has not reached the level to trigger illumination of the TPMS low EVIC or DID display.

Your vehicle has also been equipped with a TPMS malfunction indicator to indicate when the system is not operating properly. The TPMS malfunction indicator is combined with the low tire pressure telltale. When the system detects a malfunction, the telltale will flash for approximately one minute and then remain continuously illuminated. This sequence will continue each time the vehicle is restarted as long as the malfunction exists.

When the malfunction indicator is illuminated, the system may not be able to detect or signal low tire pressure as intended. TPMS malfunctions may occur for a variety of reasons, including the installation of replacement or alternate tires or wheels on the vehicle that prevent the TPMS from functioning properly. Always check the TPMS malfunction telltale after replacing one or more tires or wheels on your vehicle, to ensure that the replacement or alternate tires and wheels allow the TPMS to continue to function properly.

## **NOTE:**

Tire pressures change by approximately 1 psi (7 kPa) per 12° F (7° C) of air temperature change. Keep this in mind when checking tire pressure inside a garage, especially in the Winter. Example: If garage temperature is 68°F (20°C) and the outside temperature is 32°F (0°C), then the cold tire inflation pressure should be increased by 3 psi (21 kPa), which equals 1 psi (7 kPa) for every 12°F (7°C) for this outside temperature condition.

## **CAUTION!**

The TPMS has been optimized for the original equipment tires and wheels. TPMS pressures and warning have been established for the tire size equipped on your vehicle. Undesirable system operation or sensor damage may result when using replacement equipment that is not of the same size, type, and/or style. Aftermarket wheels can cause sensor damage. Do not use tire sealant from a can, or balance beads if your vehicle is equipped with a TPMS, as damage to the sensors may result.

## – Engine Temperature Warning Light

This light warns of an overheated engine condition.

If the light turns on and a warning chime sounds while driving, safely pull over and stop the vehicle. If the A/C system is on, turn it off. Also, shift the transmission into NEUTRAL and idle the vehicle. If the temperature reading does not return to normal, turn the engine off immediately.

We recommend that you do not operate the vehicle or engine damage will occur. Have the vehicle serviced immediately.

## **WARNING!**

A hot engine cooling system is dangerous. You or others could be badly burned by steam or boiling coolant.

# WHAT TO DO IN EMERGENCIES

## – Seat Belt Reminder Light

When the ignition switch is first turned to the ON/RUN position, this light will turn on for four to eight seconds as a bulb check. During the bulb check, if the driver's seat belt is unbuckled, a chime will sound. After the bulb check or when driving, if the driver or front passenger seat belt remains unbuckled, the Seat Belt Indicator Light will flash or remain on continuously. Refer to "Seat Belt Systems" in "Things To Know Before Starting" in your Owner's Manual on the DVD for further information.

## **BRAKE** – Brake Warning Light

This light monitors various brake functions, including brake fluid level and parking brake application. If the brake light turns on, it may indicate that the parking brake is applied, that the brake fluid level is low, or that there is a problem with the brake system master cylinder reservoir.

If the light remains on when the parking brake has been disengaged, and the fluid level is at the full mark on the master cylinder reservoir, it indicates a possible brake hydraulic system malfunction or that a problem with the Brake Booster has been detected by the Anti-Lock Brake System (ABS)/Electronic Stability Control (ESC) system. In this case, the light will remain on until the condition has been corrected. If the problem is related to the brake booster, the ABS pump will run when applying the brake, and a brake pedal pulsation may be felt during each stop.

The dual brake system provides a reserve braking capacity in the event of a failure to a portion of the hydraulic system. A leak in either half of the dual brake system is indicated by the Brake Warning Light, which will turn on when the brake fluid level in the master cylinder has dropped below a specified level. The light will remain on until the cause is corrected.

Vehicles equipped with the Anti-Lock Brake System (ABS) are also equipped with Electronic Brake Force Distribution (EBD). In the event of an EBD failure, the Brake Warning Light will turn on along with the ABS Light. Immediate repair to the ABS system is required.

Operation of the Brake Warning Light can be checked by turning the ignition switch from the OFF position to the ON/RUN position. The light should illuminate for approximately two seconds. The light should then turn off unless the parking brake is applied or a brake fault is detected. If the light does not illuminate, have the light inspected by an authorized dealer.

The light also will turn on when the parking brake is applied with the ignition switch in the ON/RUN position.

# WHAT TO DO IN EMERGENCIES

## NOTE:

This light shows only that the parking brake is applied. It does not show the degree of brake application.

### WARNING!

Driving a vehicle with the red brake light on is dangerous. Part of the brake system may have failed. It will take longer to stop the vehicle. You could have a collision. Have the vehicle checked immediately.



### – Malfunction Indicator Light (MIL)

The Malfunction Indicator Light (MIL) is part of an onboard diagnostic system called OBD II that monitors engine and automatic transmission control systems. The light will illuminate when the key is in the ON/RUN position before engine start. If the bulb does not come on when turning the key from OFF to ON/RUN, have the condition checked promptly.

Certain conditions, poor fuel quality, etc., may illuminate the light after engine start. The vehicle should be serviced if the light stays on through several of your typical driving cycles. In most situations, the vehicle will drive normally and will not require towing.

### CAUTION!

Prolonged driving with the Malfunction Indicator Light (MIL) on could cause damage to the engine control system. It also could affect fuel economy and driveability. If the MIL is flashing, severe catalytic converter damage and power loss will soon occur. Immediate service is required.

### WARNING!

A malfunctioning catalytic converter, as referenced above, can reach higher temperatures than in normal operating conditions. This can cause a fire if you drive slowly or park over flammable substances such as dry plants, wood, cardboard, etc. This could result in death or serious injury to the driver, occupants or others.



### – Electronic Stability Control (ESC) Activation/Malfunction Indicator Light

If this indicator light flashes during acceleration, apply as little throttle as possible. While driving, ease up on the accelerator. Adapt your speed and driving to the prevailing road conditions. To improve the vehicle's traction when starting off in deep snow, sand or gravel, it may be desirable to switch the ESC system off.

# WHAT TO DO IN EMERGENCIES

## INSTRUMENT CLUSTER INDICATOR LIGHTS

### – Turn Signal Indicator

The arrows will flash with the exterior turn signals when the turn signal lever is operated. A tone will chime, and a EVIC message will appear if either turn signal is left on for more than 1 mile (1.6 km).

#### **NOTE:**

If either indicator flashes at a rapid rate, check for a defective outside light bulb.

### – High Beam Indicator

Indicates that headlights are on high beam.

### – Front Fog Light Indicator

This indicator will illuminate when the front fog lights are on.

### – Vehicle Security Light

This light will flash rapidly for approximately 15 seconds when the vehicle security alarm is arming. The light will flash at a slower speed continuously after the alarm is set. The security light will also come on for about three seconds when the ignition is first turned on.

### – Electronic Stability Control (ESC) OFF Indicator Light

The ESC OFF indicator will illuminate when the Electronic Stability Control (ESC) is turned off.

### – Electronic Speed Control ON Indicator

This indicator will illuminate when the electronic speed control has been activated to the “ON” position.

### – Electronic Speed Control SET Indicator

This indicator will illuminate when the cruising speed has been set.

## Oil Change Due

Your vehicle is equipped with an engine oil change indicator system. The “Oil Change Due” message will display for 5 seconds along with a single chime to indicate the next scheduled oil change interval. The engine oil change indicator system is duty cycle based, which means the engine oil change interval may fluctuate dependent upon your personal driving style.



# WHAT TO DO IN EMERGENCIES

## Resetting The Light After Servicing

1. Without pushing the brake pedal, push the ENGINE START/STOP button and cycle the ignition to the ON/RUN position (Do not start the engine.)
2. Fully depress the accelerator pedal, slowly, three times within 10 seconds.
3. Without pushing the brake pedal, push the ENGINE START/STOP button once to return the ignition to the OFF/LOCK position.

## IF YOUR ENGINE OVERHEATS

In any of the following situations, you can reduce the potential for overheating by taking the appropriate action:

- On the highways — slow down.
- In city traffic — while stopped, shift the transmission to NEUTRAL, but do not increase engine idle speed.

### NOTE:

There are steps that you can take to slow down an impending overheat condition:

- If your air conditioner (A/C) is on, turn it off. The A/C system adds heat to the engine cooling system and turning the A/C off can help remove this heat.
- You can also turn the temperature control to maximum heat, the mode control to floor and the blower control to high. This allows the heater core to act as a supplement to the radiator and aids in removing heat from the engine cooling system.

### CAUTION!

Driving with a hot cooling system could damage your vehicle. If the temperature gauge reads HOT (H), pull over and stop the vehicle. Idle the vehicle with the air conditioner turned off until the pointer drops back into the normal range. If the pointer remains on HOT (H), and you hear continuous chimes, turn the engine off immediately, and call for service.

### WARNING!

You or others can be badly burned by hot engine coolant (antifreeze) or steam from your radiator. If you see or hear steam coming from under the hood, do not open the hood until the radiator has had time to cool. Never try to open a cooling system pressure cap when the radiator or coolant bottle is hot.

# WHAT TO DO IN EMERGENCIES

## JACKING AND TIRE CHANGING

### Jack Location

The jack and jack-handle are stowed underneath a cover in the rear storage bin in the cargo area.

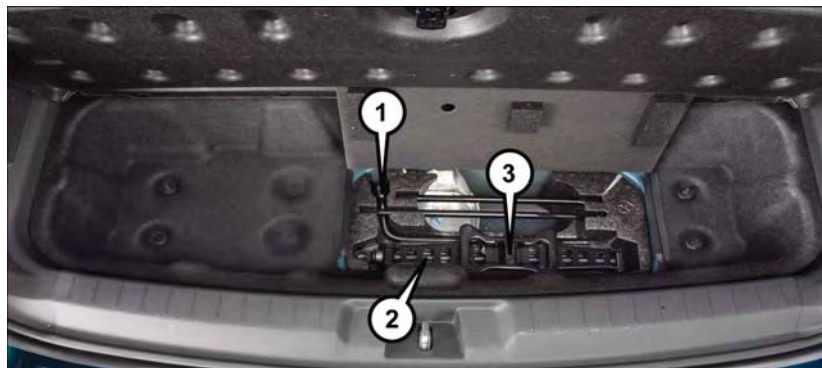

Jack/Tools Location

- 1 — Tire Changing Tools
  - 2 — Spare Tire Drive Nut (Beneath Jack)
  - 3 — Jack
- 

### Spare Tire Location

The spare tire is stowed underneath the rear of the vehicle and is held in place by means of a cable winch mechanism.

# WHAT TO DO IN EMERGENCIES

## Preparations For Jacking

1. Park the vehicle on a firm, level surface as far from the edge of the roadway as possible. Avoid icy or slippery areas.
2. Turn on the Hazard Warning flashers.
3. Set the parking brake.
4. Place the gear selector in PARK.
5. Turn OFF the ignition.
6. Block both the front and rear of the wheel diagonally opposite of the jacking position. For example, if changing the right front tire, block the left rear wheel.

### NOTE:

Passengers should not remain in the vehicle when the vehicle is being jacked.

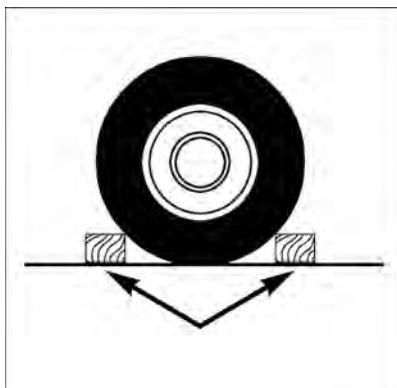

Wheel Blocked

# WHAT TO DO IN EMERGENCIES

## Spare Tire Removal

### NOTE:

On seven-passenger models, fold the third-row passenger seats flat. This will provide more space when accessing the jacking tools and when operating the winch mechanism.

1. Remove the jack-handle components 1, 2 and 3 from storage and assemble them.

### NOTE:

Assemble components 2 and 3 by seating the small ball at the end of component 2 in the small hole at the end of component 3. This will lock these components together. Assemble components 1 and 2 so that the wheel nut socket at the end of component 1 faces upward when seated on component 2. This will make it easier to rotate the assembly when operating the winch mechanism.

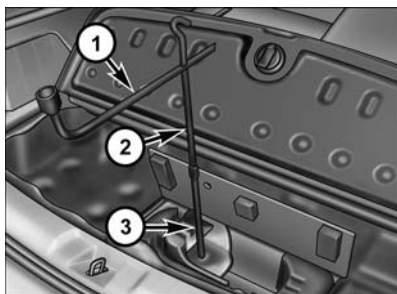

**Jack-Handle/Components Assembled**

2. Fit the assembled jack-handle over the winch drive nut located in the jack storage area. Rotate the jack-handle assembly counterclockwise until the spare tire is on the ground with enough cable slack to allow you to pull the spare tire out from underneath the vehicle.
3. Pull the spare tire out from underneath the vehicle and raise it upright so the tire's tread is on the ground.
4. Tilt the retainer at the end of the winch cable and remove it from the center of the wheel.

- 1 — Jack Handle  
2 — Component 2  
3 — Component 3

## Spare Tire Stowage

### NOTE:

Refer to "Spare Tire Removal" for information on assembling the winch tools.

1. Place the spare tire near to the winch cable. Hold the spare upright so that the tire's tread is on the ground and the valve stem is at the top of the wheel facing away from the rear of the vehicle.
2. Tilt the retainer at the end of the winch cable and drop it through the center of the wheel. Then place the spare tire with the cable and retainer underneath the vehicle.
3. Fit the assembled jack-handle over the winch drive nut. Rotate the jack-handle assembly clockwise to raise the spare tire into the storage area. Continue to rotate the jack-handle assembly until you hear the winch mechanism click three times. It cannot be over tightened. Push against the tire several times to be sure it is held securely in place.

# WHAT TO DO IN EMERGENCIES

## Jacking Instructions

1. Remove the spare tire, jack, and jack-handle from stowage.
2. Loosen, but do not remove, the wheel nuts on the wheel with the flat tire. Turn the wheel nuts counterclockwise one turn while the wheel is still on the ground.



Warning Label

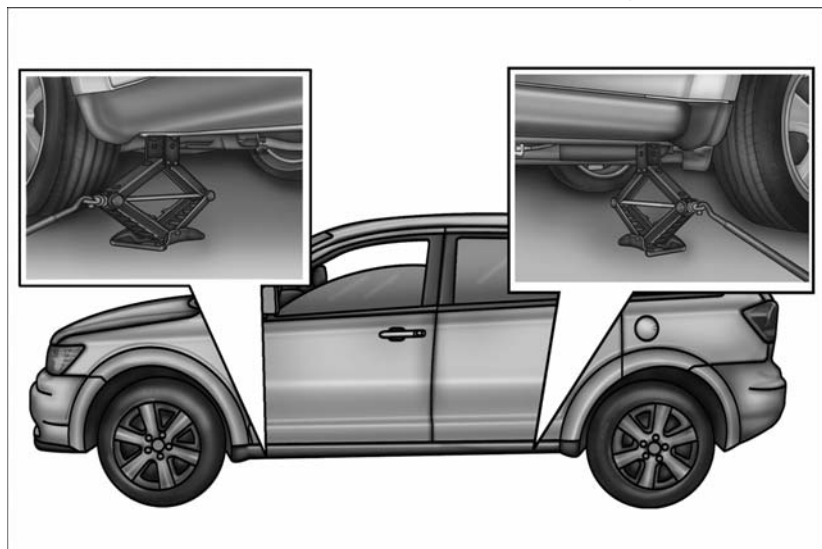

Jack Lifting Locations

# WHAT TO DO IN EMERGENCIES

3. Place the jack underneath the lift area that is closest to the flat tire. Turn the jack screw clockwise to firmly engage the jack saddle with the lift area of the sill flange.
4. Raise the vehicle by turning the jack screw clockwise with the jack handle. Raise the vehicle until the tire just clears the road surface and enough clearance is obtained to install the spare tire. Minimum tire lift provides maximum stability.
5. Remove the wheel nuts. For vehicles so equipped, remove the wheel cover from the wheel by hand. Do not pry the wheel cover off. Then pull the wheel off the hub.
6. Install the spare tire.



**Front Jacking Location**



**Rear Jacking Location**

# WHAT TO DO IN EMERGENCIES

## NOTE:

For vehicles so equipped, do not attempt to install a center cap or wheel cover on the compact spare.

7. Install the wheel nuts with the cone-shaped end of the nut toward the wheel. Lightly tighten the wheel nuts.

8. Lower the vehicle by turning the jack screw counterclockwise with the jack handle.

9. Finish tightening the lug nuts. Push down on the wrench while at the end of the handle for increased leverage. Tighten the lug nuts in a star pattern until each nut has been tightened twice. The correct tightness of each lug nut is 100 ft.lbs. (135 N·m). If in doubt about the correct tightness, have them checked with a torque wrench by you authorized dealer or service station.

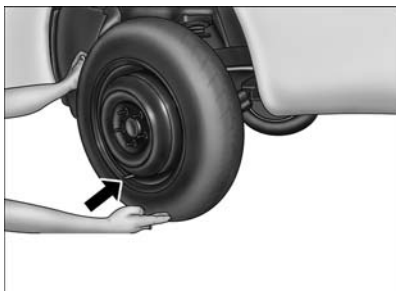

**Installing Compact Spare**

10. Lower the jack to its fully closed position.

11. Place the deflated (flat) tire in the cargo area. **Do not stow the deflated tire in the spare tire stowage location.** Have the deflated (flat) tire repaired or replaced as soon as possible.

12. To stow the winch cable and retainer, fit the assembled jack-handle over the winch drive nut. Rotate the jack-handle assembly clockwise until you hear the winch mechanism click three times. It cannot be over tightened.

13. Stow the jack-handle and jack.

14. Check the tire pressure as soon as possible. Adjust the tire pressure as required.

# WHAT TO DO IN EMERGENCIES

## Road Tire Installation

### Vehicles Equipped With Wheel Covers

1. Mount the road tire on the axle.
2. To ease the installation process for steel wheels with wheel covers, install two lug nuts on the mounting studs which are on each side of the valve stem. Install the lug nuts with the cone shaped end of the nut toward the wheel. Lightly tighten the lug nuts.
3. Align the valve notch in the wheel cover with the valve stem on the wheel. Install the cover by hand, snapping the cover over the two lug nuts. Do not use a hammer or excessive force to install the cover.
4. Install the remaining lug nuts with the cone shaped end of the nut toward the wheel. Lightly tighten the lug nuts.
5. Lower the vehicle to the ground by turning the jack handle counterclockwise.
6. Finish tightening the lug nuts. Push down on the wrench while at the end of the handle for increased leverage. Tighten the lug nuts in a star pattern until each nut has been tightened twice. The correct tightness of each lug nut is 100 ft.lbs. (135 N·m). If in doubt about the correct tightness, have them checked with a torque wrench by your authorized dealer or service station.
7. After 25 miles (40 km) check the lug nut torque with a torque wrench to ensure that all lug nuts are properly seated against the wheel.

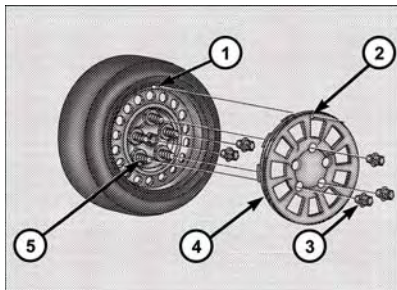

**Wheel Cover Installation**

- 1 — Valve Stem
- 2 — Valve Notch
- 3 — Wheel Lug Nut
- 4 — Wheel Cover
- 5 — Mounting Stud

### Vehicles Without Wheel Covers

1. Mount the road tire on the axle.
2. Install the remaining lug nuts with the cone shaped end of the nut toward the wheel. Lightly tighten the lug nuts.
3. Lower the vehicle to the ground by turning the jack handle counterclockwise.
4. Finish tightening the lug nuts. Push down on the wrench while at the end of the handle for increased leverage. Tighten the lug nuts in a star pattern until each nut has been tightened twice. The correct tightness of each lug nut is 100 ft.lbs. (135 N·m). If in doubt about the correct tightness, have them checked with a torque wrench by your authorized dealer or service station.
5. After 25 miles (40 km) check the lug nut torque with a torque wrench to ensure that all lug nuts are properly seated against the wheel.



# WHAT TO DO IN EMERGENCIES

## CAUTION!

- The winch mechanism is designed for use with the jack-handle only. Use of an air wrench or other power tools is not recommended and they can damage the winch.
- Do not attempt to raise the vehicle by jacking on locations other than those indicated in the Jacking Instructions for this vehicle.
- Be sure to mount the spare tire with the valve stem facing outward. The vehicle could be damaged if the spare tire is mounted incorrectly.

## WARNING!

- Do not attempt to change a tire on the side of the vehicle close to moving traffic. Pull far enough off the road to avoid the danger of being hit when operating the jack or changing the wheel.
- Being under a jacked-up vehicle is dangerous. The vehicle could slip off the jack and fall on you. You could be crushed. Never put any part of your body under a vehicle that is on a jack. If you need to get under a raised vehicle, take it to an authorized service center where it can be raised on a lift.
- Never start or run the engine while the vehicle is on a jack.
- The jack is designed to be used as a tool for changing tires only. The jack should not be used to lift the vehicle for service purposes. The vehicle should be jacked on a firm level surface only. Avoid ice or slippery areas.
- Carefully follow these tire changing warnings to help prevent personal injury or damage to your vehicle:
- Always park on a firm, level surface as far from the edge of the roadway as possible before raising the vehicle.
- Turn on the Hazard Warning flasher.
- Block the wheel diagonally opposite the wheel to be raised.
- Set the parking brake firmly and set an automatic transmission in PARK.
- Do not let anyone sit in the vehicle when it is on a jack.
- Do not get under the vehicle when it is on a jack.
- Only use the jack in the positions indicated and for lifting this vehicle during a tire change.
- If working on or near a roadway, be extremely careful of motor traffic.
- To assure that spare tires, flat or inflated, are securely stowed, spares must be stowed with the valve stem facing the ground.
- Raising the vehicle higher than necessary can make the vehicle less stable. It could slip off the jack and hurt someone near it. Raise the vehicle only enough to remove the tire.
- To avoid possible personal injury, handle the wheel covers with care to avoid contact with any sharp edges.
- To avoid the risk of forcing the vehicle off the jack, do not tighten the wheel nuts fully until the vehicle has been lowered. Failure to follow this warning may result in personal injury.
- A loose tire or jack, thrown forward in a collision or hard stop could endanger the occupants of the vehicle. Always stow the jack parts and the spare tire in the places provided. Have the deflated (flat) tire repaired or replaced immediately.

# WHAT TO DO IN EMERGENCIES

## JUMP-STARTING

If your vehicle has a discharged battery it can be jump-started using a set of jumper cables and a battery in another vehicle or by using a portable battery booster pack.

Jump-starting can be dangerous if done improperly so please follow the procedures in this section carefully.

### NOTE:

When using a portable battery booster pack follow the manufacturer's operating instructions and precautions.

### Preparations For Jump-Start

The battery in your vehicle is located between the left front headlight assembly and the left front wheel splash shield. To allow jump-starting there are remote battery posts located on the left side of the engine compartment.

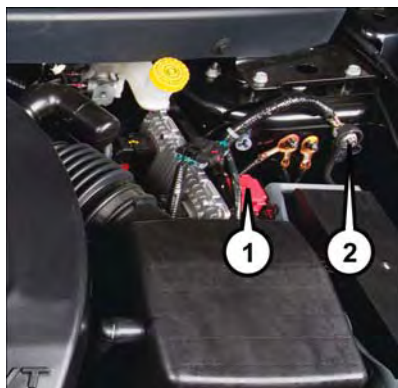

**Remote Battery Post Locations**

- 1 — Remote Positive (+) Battery Post
- 2 — Remote Negative (-) Battery Post

1. Set the parking brake, shift the automatic transmission into PARK and turn the ignition to LOCK.
2. Turn off the heater, radio, and all unnecessary electrical accessories.
3. Remove the protective cover over the remote positive (+) battery post. To remove the cover, push the locking tab and pull upward on the cover.
4. If using another vehicle to jump-start the battery, park the vehicle within the jumper cables reach, set the parking brake and make sure the ignition is OFF.

### Jump-Starting Procedure

1. Connect the positive (+) end of the jumper cable to the remote positive (+) post of the vehicle with discharged battery.
2. Connect the opposite end of the positive (+) jumper cable to the positive (+) post of the booster battery.
3. Connect the negative (-) end of the jumper cable to the negative (-) post of the booster battery.
4. Connect the opposite end of the negative (-) jumper cable to the remote negative (-) post of the vehicle with the discharged battery.
5. Start the engine in the vehicle that has the booster battery, let the engine idle a few minutes, and then start the engine in the vehicle with the discharged battery.

# WHAT TO DO IN EMERGENCIES

Once the engine is started, remove the jumper cables in the reverse sequence:

1. Disconnect the negative (-) end of the jumper cable from the remote negative (-) post of the vehicle with the discharged battery.
2. Disconnect the opposite end of the negative (-) jumper cable from the negative (-) post of the booster battery.
3. Disconnect the positive (+) end of the jumper cable from the positive (+) post of the booster battery.
4. Disconnect the opposite end of the positive (+) jumper cable from the remote positive (+) post of the discharged vehicle.
5. Reinstall the protective cover over the remote positive (+) post of the vehicle with the discharged battery.
6. Reinstall the protective plug over the remote negative (-) post of the vehicle with the discharged battery.

**NOTE:**

If frequent jump-starting is required to start your vehicle you should have the battery and charging system inspected at your authorized dealer.

## CAUTION!

- Do not use a portable battery booster pack or any other booster source with a system voltage greater than 12 Volts or damage to the battery, starter motor, alternator or electrical system may occur.
- Failure to follow these procedures could result in damage to the charging system of the booster vehicle or the discharged vehicle.
- Accessories that can be plugged into the vehicle power outlets draw power from the vehicle's battery, even when not in use (e.g., cellular phones, etc.). Eventually, if plugged in long enough, the vehicle's battery discharges sufficiently to degrade battery life and/or prevent the engine from starting.

# WHAT TO DO IN EMERGENCIES

## WARNING!

- When temperatures are below the freezing point, electrolyte in a discharged battery may freeze. Do not attempt jump-starting because the battery could rupture or explode and cause personal injury. Battery temperature must be brought above the freezing point before attempting a jump-start.
- Take care to avoid the radiator cooling fan whenever the hood is raised. It can start anytime the ignition switch is on. You can be injured by moving fan blades.
- Remove any metal jewelry, such as watch bands or bracelets, that might make an inadvertent electrical contact. You could be severely injured.
- Batteries contain sulfuric acid that can burn your skin or eyes and generate hydrogen gas which is flammable and explosive. Keep open flames or sparks away from the battery.
- Do not allow vehicles to touch each other as this could establish a ground connection and personal injury could result.
- Failure to follow this procedure could result in personal injury or property damage due to battery explosion.
- Do not connect the cable to the negative post (-) of the discharged battery. The resulting electrical spark could cause the battery to explode and could result in personal injury.

## GEAR SELECTOR OVERRIDE

If a malfunction occurs and the gear selector cannot be moved out of the PARK position, you can use the following procedure to temporarily move the gear selector:

1. To access the gear selector override, remove the cubby bin liner located in the center console behind the gear selector. The override access port is at the front of the cubby bin.
2. Firmly apply the parking brake.
3. Push and maintain firm pressure on the brake pedal.
4. Insert a screwdriver or similar tool through the access port and push and hold the override release lever forward.
5. Move the gear selector into the NEUTRAL position.
6. The vehicle may then be started in NEUTRAL.
7. Reinstall the override cover.

# WHAT TO DO IN EMERGENCIES

## TOWING A DISABLED VEHICLE

Towing Condition	Wheel OFF the Ground	FWD MODELS	AWD MODELS
Flat Tow	NONE	<b>IF transmission is operable:</b> <ul style="list-style-type: none"><li>• Transmission in <b>NEUTRAL</b></li><li>• 25 mph (40 km/h) <b>max</b> speed</li><li>• 15 miles (24 km) <b>max</b> distance</li></ul>	<b>NOT ALLOWED</b>
Wheel Lift Or Dolly Tow	Rear		<b>NOT ALLOWED</b>
	Front	OK	<b>NOT ALLOWED</b>
Flatbed	<b>ALL</b>	<b>BEST METHOD</b>	OK

If the key fob is unavailable, or the vehicle's battery is discharged, refer to "Gear Selector Override" in this section for instructions on shifting the transmission out of PARK for towing.

## FREEING A STUCK VEHICLE

If your vehicle becomes stuck in mud, sand or snow, it can often be moved using a rocking motion. Turn your steering wheel right and left to clear the area around the front wheels. Then shift back and forth between DRIVE and REVERSE while gently pressing the accelerator. Use the least amount of accelerator pedal pressure that will maintain the rocking motion, without spinning the wheels or racing the engine.

### NOTE:

Push the "ESC Off" switch, to place the Electronic Stability Control (ESC) system in "Partial Off" mode before rocking the vehicle. Once the vehicle has been freed, push the "ESC Off" switch again to restore "ESC On" mode.

### CAUTION!

- When "rocking" a stuck vehicle by shifting between REVERSE and DRIVE, do not spin the wheels faster than 15 mph (24 km/h), or drivetrain damage may result.
- Revving the engine or spinning the wheels too fast may lead to transmission overheating and failure. It can also damage the tires. Do not spin the wheels above 30 mph (48 km/h) while in gear (no transmission shifting occurring).

# WHAT TO DO IN EMERGENCIES

## **WARNING!**

Fast spinning tires can be dangerous. Forces generated by excessive wheel speeds may cause tire damage or failure. A tire could explode and injure someone. Do not spin your vehicle's wheels faster than 30 mph (48 km/h) when you are stuck. Do not let anyone near a spinning wheel, no matter what the speed.

## **ENHANCED ACCIDENT RESPONSE SYSTEM (EARS)**

This vehicle is equipped with an Enhanced Accident Response System.

Please refer to “Supplemental Restraint System (SRS) — Air Bags” in “Getting Started” in this guide for further information on the Enhanced Accident Response System (EARS) function.

## **EVENT DATA RECORDER (EDR)**

This vehicle is equipped with an event data recorder (EDR). The main purpose of an EDR is to record, in certain crash or near crash-like situations, such as an air bag deployment or hitting a road obstacle, data that will assist in understanding how a vehicle's systems performed.

Please refer to “Supplemental Restraint System (SRS) — Air Bags” in “Getting Started” in this guide for further information on the Event Data Recorder (EDR).

# MAINTAINING YOUR VEHICLE

## OPENING THE HOOD

1. Pull the hood release lever located under the left side of the instrument panel.
2. Raise the hood and locate the safety latch, in the middle of the hood opening.
3. Move the safety latch while lifting the hood at the same time.
4. Insert the support rod into the slot on the hood.
5. To close the hood, remove the support rod and place it in the retaining clip, then lower the hood slowly.



Hood Release Lever Location

### WARNING!

Be sure the hood is fully latched before driving your vehicle. If the hood is not fully latched, it could open when the vehicle is in motion and block your vision. Failure to follow this warning could result in serious injury or death.

# MAINTAINING YOUR VEHICLE

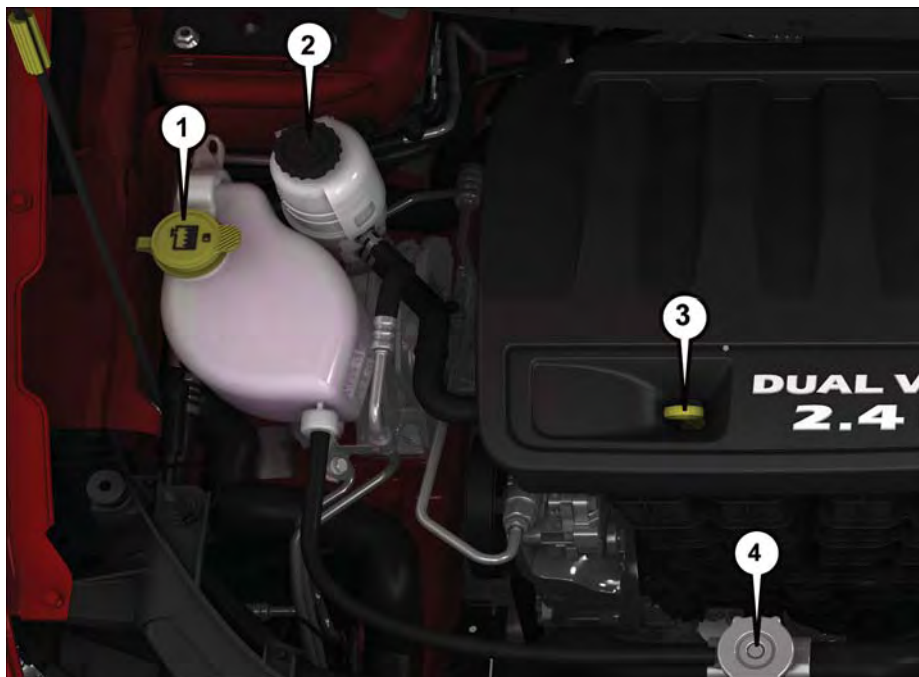

## ENGINE COMPARTMENT — 2.4L

1. Engine Coolant Reservoir Cap
2. Power Steering Fluid Reservoir
3. Engine Oil Dipstick
4. Engine Coolant Pressure Cap
5. Engine Oil Fill



# MAINTAINING YOUR VEHICLE

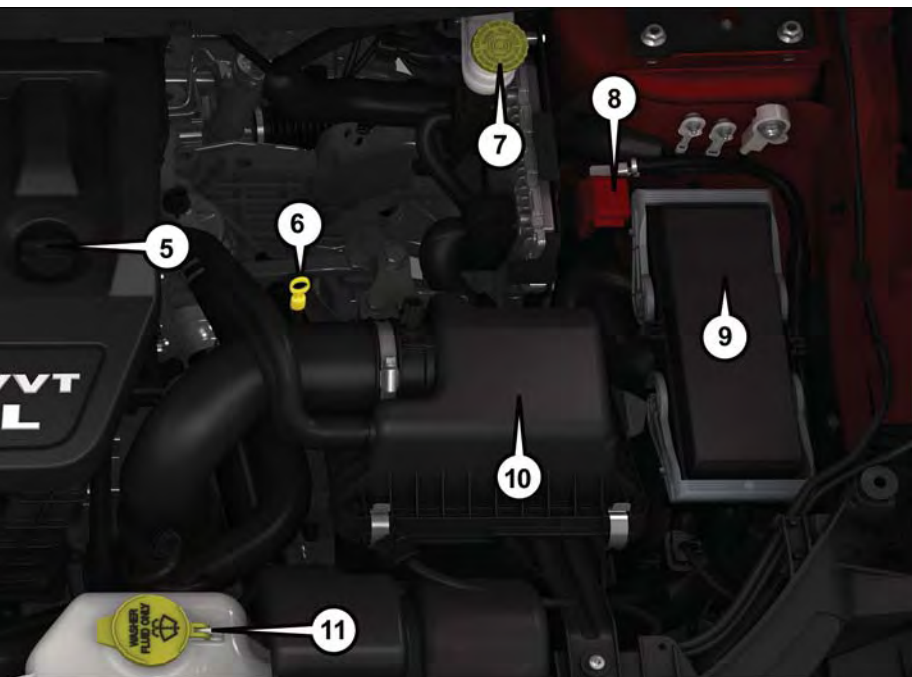

- 6. Transmission Dipstick (4 speed only)
- 7. Brake Fluid Reservoir
- 8. Remote Jump Start Positive Terminal
- 9. Power Distribution Center (Fuses)
- 10. Air Cleaner Filter
- 11. Washer Fluid Reservoir

# MAINTAINING YOUR VEHICLE

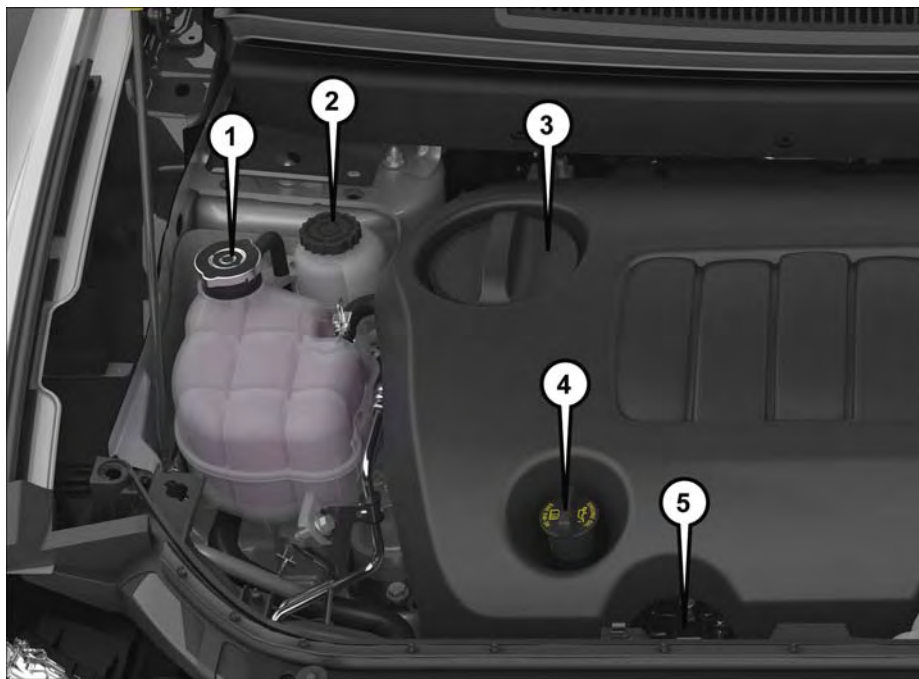

## ENGINE COMPARTMENT — 3.6L

1. Engine Coolant Pressure Cap
2. Power Steering Reservoir
3. Engine Oil Filter Access
4. Engine Oil Fill
5. Engine Oil Dipstick

# MAINTAINING YOUR VEHICLE

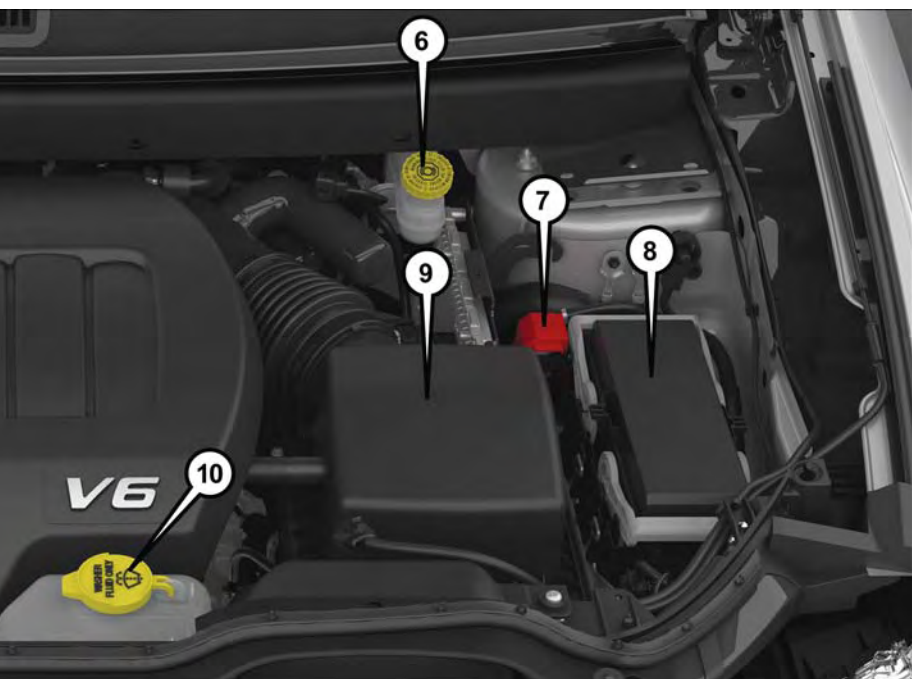

- 6. Brake Fluid Reservoir
- 7. Remote Jump Start Positive Terminal
- 8. Power Distribution Center (Fuses)
- 9. Air Cleaner Filter
- 10. Washer Fluid Reservoir

# MAINTAINING YOUR VEHICLE

## FLUID CAPACITIES

	U.S.	Metric
<b>Fuel (Approximate)</b>		
Front Wheel Drive (FWD) Models	20.5 Gallons	77.6 Liters
All-Wheel Drive Models	21 Gallons	79.8 Liters
<b>Engine Oil With Filter</b>		
2.4L Engine (SAE 5W-20, API Certified)	4.5 Quarts	4.26 Liters
3.6L Engine (SAE 5W-20, API Certified)	6 Quarts	5.6 Liters
<b>Cooling System*</b>		
2.4L Engine and Single or Dual-Zone Climate Control System (MOPAR Antifreeze/Engine Coolant 10 Year/150,000 Mile Formula)	10.7 Quarts	10.1 Liters
2.4L Engine and Three-Zone Climate Control System (MOPAR Antifreeze/Engine Coolant 10 Year/150,000 Mile Formula)	11.6 Quarts	11 Liters
3.6L Engine and Single or Dual-Zone Climate Control System (MOPAR Antifreeze/Engine Coolant 10 Year/150,000 Mile Formula)	13.1 Quarts	12.4 Liters
3.6L Engine and Three-Zone Climate Control System (MOPAR Antifreeze/Engine Coolant 10 Year/150,000 Mile Formula)	14.5 Quarts	13.7 Liters
* Includes heater and coolant recovery bottle filled to MAX level.		

## FLUIDS, LUBRICANTS, AND GENUINE PARTS

### Engine

Component	Fluid, Lubricant, or Genuine Part
Engine Coolant	We recommend you use MOPAR Antifreeze/Coolant 10 Year/150,000 Mile Formula OAT (Organic Additive Technology).
Engine Oil	We recommend you use API Certified SAE 5W-20 Engine Oil, meeting the requirements of FCA Material Standard MS-6395 such as MOPAR, Pennzoil, and Shell Helix. Refer to your engine oil filler cap for correct SAE grade.
Engine Oil Filter	We recommend you use MOPAR Engine Oil Filter.
Spark Plugs	We recommend you use MOPAR Spark Plugs.
Fuel Selection	87 Octane, 0-15% Ethanol.
Fuel Selection – 3.6L Flex Fuel (E85) Engine – If Equipped	87 Octane, Up To 85% Ethanol.

# MAINTAINING YOUR VEHICLE

## CAUTION!

- Mixing of engine coolant (antifreeze) other than specified Organic Additive Technology (OAT) engine coolant (antifreeze), may result in engine damage and may decrease corrosion protection. Organic Additive Technology (OAT) engine coolant is different and should not be mixed with Hybrid Organic Additive Technology (HOAT) engine coolant (antifreeze) or any “globally compatible” coolant (antifreeze). If a non-OAT engine coolant (antifreeze) is introduced into the cooling system in an emergency, the cooling system will need to be drained, flushed, and refilled with fresh OAT coolant (conforming to MS.90032), by an authorized dealer as soon as possible.
- Do not use water alone or alcohol-based engine coolant (antifreeze) products. Do not use additional rust inhibitors or antirust products, as they may not be compatible with the radiator engine coolant and may plug the radiator.
- This vehicle has not been designed for use with propylene glycol-based engine coolant (antifreeze). Use of propylene glycol-based engine coolant (antifreeze) is not recommended.

## Chassis

Component	Fluid, Lubricant, or Genuine Part
Automatic Transmission	Use only ATF+4 Automatic Transmission Fluid. Failure to use ATF+4 fluid may affect the function or performance of your transmission. We recommend MOPAR ATF+4 fluid.
Power Transfer Unit (PTU)	We recommend you use MOPAR Gear Lubricant 75W-90.
Rear Drive Assembly (RDA)	We recommend you use MOPAR Gear Lubricant 75W-90.
Brake Master Cylinder	We recommend you use MOPAR DOT 3, SAE J1703. If DOT 3 brake fluid is not available, then DOT 4 is acceptable.
Power Steering Reservoir	We recommend you use MOPAR Power Steering Fluid + 4, or MOPAR ATF+4 Automatic Transmission Fluid.

## FLEXIBLE FUEL (3.6L ENGINE ONLY) — IF EQUIPPED

### E-85 General Information

The information in this section is unique for Flexible Fuel vehicles only. These vehicles can be identified by a unique fuel filler door label that states **Ethanol (E-85) or Unleaded Gasoline Only** and a yellow fuel cap. Refer to the Owner's Manual on the DVD for further information.

## CAUTION!

Only vehicles with the E-85 fuel filler door label or a yellow gas cap can operate on E-85.

# MAINTAINING YOUR VEHICLE

## MAINTENANCE PROCEDURES

For information on the maintenance procedures for your vehicle, please refer to “Maintenance Procedures” in “Maintaining Your Vehicle” in your Owner’s Manual or applicable supplement on the DVD for further details.

## MAINTENANCE SCHEDULE

Your vehicle is equipped with an automatic oil change indicator system. The oil change indicator system will remind you that it is time to take your vehicle in for scheduled maintenance.

Based on engine operation conditions, the oil change indicator message will illuminate. This means that service is required for your vehicle. Operating conditions such as frequent short-trips, trailer tow, extremely hot or cold ambient temperatures, and E85 fuel usage will influence when the “Change Oil” or “Oil Change Required” message is displayed. Severe Operating Conditions can cause the change oil message to illuminate as early as 3,500 miles (5,600 km) since last reset. Have your vehicle serviced as soon as possible, within the next 500 miles (805 km).

Your authorized dealer will reset the oil change indicator message after completing the scheduled oil change. If a scheduled oil change is performed by someone other than your authorized dealer, the message can be reset by referring to the steps described under “Instrument Cluster Warning Lights” in “What To Do In Emergencies” in this guide or “Electronic Vehicle Information Center (EVIC)” in “Understanding Your Instrument Panel” in your Owner’s Manual on the DVD for further information.

### NOTE:

Under no circumstances should oil change intervals exceed 10,000 miles (16,000 km), twelve months or 350 hours of engine run time, whichever comes first. The 350 hours of engine run or idle time is generally only a concern for fleet customers.

### Severe Duty All Models

Change Engine Oil at 4,000 miles (6,500 km) if the vehicle is operated in a dusty and off road environment or is operated predominately at idle or only very low engine RPM’s. This type of vehicle use is considered Severe Duty.

# MAINTAINING YOUR VEHICLE

## Once A Month Or Before A Long Trip:

- Check engine oil level.
- Check windshield washer fluid level.
- Check tire pressure and look for unusual wear or damage. Rotate tires at the first sign of irregular wear, even if it occurs before the oil indicator system turns on.
- Check the fluid levels of the coolant reservoir, brake master cylinder, power steering and transmission (4-speed only) and fill as needed.
- Check function of all interior and exterior lights.

## Required Maintenance Intervals.

Refer to the Maintenance Schedules on the following page for the required maintenance intervals.

<b>At Every Oil Change Interval As Indicated By Oil Change Indicator System:</b>
• Change oil and filter.
• Rotate the tires. <b>Rotate at the first sign of irregular wear, even if it occurs before the oil indicator system turns on.</b>
• Inspect battery and clean and tighten terminals as required.
• Inspect automatic transmission fluid if equipped with dipstick.
• Inspect brake pads, shoes, rotors, drums, hoses and park brake.
• Inspect engine cooling system protection and hoses.
• Inspect exhaust system.
• Inspect engine air cleaner if using in dusty or off-road conditions.

# MAINTAINING YOUR VEHICLE

## Maintenance Chart

Refer to the Maintenance Schedules on the following pages for the required maintenance intervals.

Mileage or time passed (whichever comes first)	20,000	30,000	40,000	50,000	60,000	70,000	80,000	90,000	100,000	110,000	120,000	130,000	140,000	150,000
Or Years:	2	3	4	5	6	7	8	9	10	11	12	13	14	15
Or Kilometers:	32,000	48,000	64,000	80,000	96,000	112,000	128,000	144,000	160,000	176,000	192,000	208,000	224,000	240,000
<b>Additional Inspections</b>														
Inspect the CV joints.	X		X					X			X			X
Inspect front suspension, tie rod ends, and replace if necessary.	X	X	X				X		X		X		X	
Inspect the brake linings, parking brake function.	X		X		X		X		X		X		X	
<b>Additional Maintenance</b>														
Replace engine air filter.		X			X			X			X			X
Replace air conditioning filter.	X		X		X		X		X		X		X	
Replace spark plugs (2.4L Engine). **		X			X			X			X			X
Replace spark plugs (3.6L Engine). **									X					
Flush and replace the engine coolant at 10 years or 150,000 miles (240,000 km) whichever comes first.									X					X
Change the automatic transmission fluid and filter.											X			
Change the automatic transmission fluid and filter if using your vehicle for any of the following: police, taxi, fleet, or frequent trailer towing.					X						X			



Mileage or time passed (whichever comes first)	2	3	4	5	6	7	8	9	10	11	12	13	14	15
Or Years:	20,000	30,000	40,000	50,000	60,000	70,000	80,000	90,000	100,000	110,000	120,000	130,000	140,000	150,000
Or Kilometers:	32,000	48,000	64,000	80,000	96,000	112,000	128,000	144,000	160,000	176,000	192,000	208,000	224,000	240,000
Replace rear drive assembly (RDA) fluid.					X						X			
Replace power transfer unit (PTU) fluid.					X						X			
Inspect and replace PCV valve if necessary.									X					

\*\* The spark plug change interval is mileage based only, yearly intervals do not apply.

## WARNING!

- You can be badly injured working on or around a motor vehicle. Do only service work for which you have the knowledge and the right equipment. If you have any doubt about your ability to perform a service job, take your vehicle to a competent mechanic.
- Failure to properly inspect and maintain your vehicle could result in a component malfunction and effect vehicle handling and performance. This could cause an accident.

# MAINTAINING YOUR VEHICLE

## MAINTENANCE RECORD

	Odometer	Date	Signature, Authorized Service Center
20,000 Miles (32,000 km) or 2 Years			
30,000 Miles (48,000 km) or 3 Years			
40,000 Miles (64,000 km) or 4 Years			
50,000 Miles (80,000 km) or 5 Years			
60,000 Miles (96,000 km) or 6 Years			
70,000 Miles (112,000 km) or 7 Years			
80,000 Miles (128,000 km) or 8 Years			

	Odometer	Date	Signature, Authorized Service Center
90,000 Miles (144,000 km) or 9 Years			
100,000 Miles (160,000 km) or 10 Years			
110,000 Miles (176,000 km) or 11 Years			
120,000 Miles (192,000 km) or 12 Years			
130,000 Miles (208,000 km) or 13 Years			
140,000 Miles (224,000 km) or 14 Years			
150,000 Miles (240,000 km) or 15 Years			

# MAINTAINING YOUR VEHICLE

## FUSES

### WARNING!

- When replacing a blown fuse, always use an appropriate replacement fuse with the same amp rating as the original fuse. Never replace a fuse with another fuse of higher amp rating. Never replace a blown fuse with metal wires or any other material. Failure to use proper fuses may result in serious personal injury, fire and/or property damage.
- Before replacing a fuse, make sure that the ignition is off and that all the other services are switched off and/or disengaged.
- If the replaced fuse blows again, contact an authorized dealer.
- If a general protection fuse for safety systems (air bag system, braking system), power unit systems (engine system, gearbox system) or steering system blows, contact an authorized dealer.

### Interior Fuses

The interior fuse panel is located on the passenger side under the instrument panel.

Cavity	Cartridge Fuse	Mini-Fuse	Description
F100	30 Amp Pink	–	110V AC Inverter – If Equipped
F101	–	10 Amp Red	Interior Lights
F102	–	20 Amp Yellow	Cigar Lighter in Instrument Panel/ Left Rear Power Outlet
F103	–	20 Amp Yellow	Power Outlet in Console Bin/Power Outlet in Rear of Console
F105	–	20 Amp Yellow	Heated Seats – If Equipped
F106	–	20 Amp Yellow	Rear Power Outlet
F107	–	10 Amp Red	Rear Camera – If Equipped
F108	–	15 Amp Blue	Instrument Panel
F109	–	10 Amp Red	Climate Control/HVAC
F110	–	10 Amp Red	Occupant Restraint Controller
F112	–	10 Amp Red	Spare
F114	–	20 Amp Yellow	Rear HVAC Blower/Motor
F115	–	20 Amp Yellow	Rear Wiper Motor
F116	30 Amp Pink	–	Rear Defroster (EBL)
F117	–	10 Amp Red	Heated Mirrors
F118	–	10 Amp Red	Occupant Restraint Controller
F119	–	10 Amp Red	Steering Column Control Module
F120	–	10 Amp Red	All Wheel Drive – If Equipped
F121	–	15 Amp Blue	Wireless Ignition Node
F122	–	25 Amp Clear	Driver Door Module
F123	–	25 Amp Clear	Passenger Door Module

# MAINTAINING YOUR VEHICLE

Cavity	Cartridge Fuse	Mini-Fuse	Description
F124	–	10 Amp Red	Mirrors
F125	–	10 Amp Red	Steering Column Control Module
F126	–	25 Amp Clear	Audio Amplifier
F127	–	20 Amp Yellow	Trailer Tow – If Equipped
F128	–	15 Amp Blue	Radio
F129	–	15 Amp Blue	Video/DVD – If Equipped
F130	–	15 Amp Blue	Climate Control/Instrument Panel
F131	–	10 Amp Red	Passenger Assistance/Hands Free System – If Equipped
F132	–	10 Amp Red	Tire Pressure Module
F133	–	10 Amp Red	Spare

## Underhood Fuses (Power Distribution Center)

The power distribution center is located in the engine compartment.

Cavity	Cartridge Fuse	Mini-Fuse	Description
F101	60 Amp Yellow	–	Interior Power Distribution Center Rail
F102	60 Amp Yellow	–	Interior Power Distribution Center Rail
F103	60 Amp Yellow	–	Interior Power Distribution Center Rail
F105	60 Amp Yellow	–	Interior Power Distribution Center Rail Ignition Run Relay
F106	60 Amp Yellow	–	Interior Power Distribution Center Rail Run/Accessory Relays
F139	40 Amp Green	–	Climate Control System Blower
F140	30 Amp Pink	–	Power Locks
F141	40 Amp Green	–	Anti-Lock Brake System
F142	40 Amp Green	–	Glow Plugs – If Equipped
F143	40 Amp Green	–	Exterior Lights 1
F144	40 Amp Green	–	Exterior Lights 2
F145	30 Amp Pink	–	To Body Computer – Lamp
F146	30 Amp Pink	–	Spare
F147	30 Amp Pink	–	Spare
F148	40 Amp Green	–	Radiator Fan Motor
F149	30 Amp Pink	–	Starter Solenoid
F150	–	25 Amp Clear	Powertrain Control Modules
F151	30 Amp Pink	–	Headlamp Washer Motor – If Equipped
F152	–	25 Amp Clear	Diesel Fuel Heater – If Equipped

# MAINTAINING YOUR VEHICLE

<b>Cavity</b>	<b>Cartridge Fuse</b>	<b>Mini-Fuse</b>	<b>Description</b>
F153	–	20 Amp Yellow	Fuel Pump
F156	–	10 Amp Red	Brake/Electronic Stability Control Module
F157	–	10 Amp Red	Power Transfer Unit Module – If Equipped
F158	–	10 Amp Red	Active Hood Module – If Equipped
F159	–	10 Amp Red	Spare
F160	–	20 Amp Yellow	Interior Lights
F161	–	20 Amp Yellow	Horn
F162	40 Amp Red/20 Amp Lt. Blue	–	Cabin Heater #1/Vacuum Pump – If Equipped
F163	50 Amp Red	–	Cabin Heater #2 – If Equipped
F164	–	25 Amp Clear	Powertrain Auto Shutdown
F165	–	20 Amp Yellow	Powertrain Shutdown
F166	–	20 Amp Yellow	Spare
F167	–	30 Amp Green	Powertrain Shutdown
F168	–	10 Amp Red	Air Conditioner Clutch
F169	40 Amp Green	–	Emissions – Partial Zero Emissions Vehicle Motor
F170	–	15 Amp Blue	Emissions – Partial Zero Emissions Vehicle Actuators
F172	–	20 Amp Yellow	Spare
F173	–	25 Amp Clear	Anti Lock Brake Valves
F174	–	20 Amp Yellow	Siren – If Equipped
F175	–	30 Amp Green	Spare
F176	–	10 Amp Red	Powertrain Control Modules
F177	–	20 Amp Yellow	All Wheel Drive Module – If Equipped
F178	–	25 Amp Clear	Sunroof – If Equipped
F179	–	10 Amp Red	Battery Sensor
F181	100 Amp Blue	–	Electrohydraulic Steering (EHPS) – If Equipped
F182	50 Amp Red	–	Cabin Heater #3 – If Equipped
F184	30 Amp Pink	–	Front Wiper Motor

# MAINTAINING YOUR VEHICLE

## TIRES — GENERAL INFORMATION

### TIRE PRESSURES

Check the inflation pressure of each tire, including the spare tire (if equipped), at least monthly and inflate to the recommended pressure for your vehicle.

The tire pressures recommended for your vehicle are found on the “Tire and Loading Information” label located on the driver’s side door opening or B pillar.

#### NOTE:

Refer to the Owner’s Manual on the DVD or the Tire Information Supplement located in your Owner’s Information kit for more information regarding tire warnings and instructions.



Tire And Loading Information Location (Example)

### WARNING!

- Overloading of your tires is dangerous. Overloading can cause tire failure, affect vehicle handling, and increase your stopping distance. Use tires of the recommended load capacity for your vehicle. Never overload them.
- Improperly inflated tires are dangerous and can cause collisions. Under-inflation increases tire flexing and can result in over-heating and tire failure. Over-inflation reduces a tire's ability to cushion shock. Objects on the road and chuck holes can cause damage that results in tire failure. Unequal tire pressures can cause steering problems. You could lose control of your vehicle. Over-inflated or under-inflated tires can affect vehicle handling and can fail suddenly, resulting in loss of vehicle control. Always drive with each tire inflated to the recommended cold tire inflation pressure.

# MAINTAINING YOUR VEHICLE

## SPARE TIRES — IF EQUIPPED

### NOTE:

For vehicles equipped with Tire Service Kit instead of a spare tire, please refer to “Tire Service Kit” in “What To Do In Emergencies” on your DVD for further information.

### CAUTION!

Because of the reduced ground clearance, do not take your vehicle through an automatic car wash with a compact or limited-use temporary spare installed. Damage to the vehicle may result.

## Spare Tire Matching Original Equipped Tire And Wheel — If Equipped

Your vehicle may be equipped with a spare tire and wheel equivalent in look and function to the original equipment tire and wheel found on the front or rear axle of your vehicle. This spare tire may be used in the tire rotation for your vehicle. If your vehicle has this option, refer to an authorized tire dealer for the recommended tire rotation pattern.

## Compact Spare Tire — If Equipped

The compact spare is for temporary emergency use only. You can identify if your vehicle is equipped with a compact spare by looking at the spare tire description on the Tire and Loading Information Placard located on the driver’s side door opening or on the sidewall of the tire. Compact spare tire descriptions begin with the letter “T” or “S” preceding the size designation. Example: T145/80D18 103M.

T, S = Temporary Spare Tire

Since this tire has limited tread life, the original equipment tire should be repaired (or replaced) and reinstalled on your vehicle at the first opportunity.

Do not install a wheel cover or attempt to mount a conventional tire on the compact spare wheel, since the wheel is designed specifically for the compact spare tire. Do not install more than one compact spare tire and wheel on the vehicle at any given time.

### WARNING!

Compact spares are for temporary emergency use only. With these spares, do not drive more than 50 mph (80 km/h). Temporary use spares have limited tread life. When the tread is worn to the tread wear indicators, the temporary use spare tire needs to be replaced. Be sure to follow the warnings, which apply to your spare. Failure to do so could result in spare tire failure and loss of vehicle control.

# MAINTAINING YOUR VEHICLE

## Full Size Spare — If Equipped

The full size spare is for temporary emergency use only. This tire may look like the originally equipped tire on the front or rear axle of your vehicle, but it is not. This spare tire may have limited tread life. When the tread is worn to the tread wear indicators, the temporary use full size spare tire needs to be replaced. Since it is not the same as your original equipment tire, replace (or repair) the original equipment tire and reinstall on the vehicle at the first opportunity.

## Limited Use Spare — If Equipped

The limited-use spare tire is for temporary emergency use only. This tire is identified by a label located on the limited-use spare wheel. This label contains the driving limitations for this spare. This tire may look like the original equipped tire on the front or rear axle of your vehicle, but it is not. Installation of this limited-use spare tire affects vehicle handling. Since it is not the same as your original equipment tire, replace (or repair) the original equipment tire and reinstall on the vehicle at the first opportunity.

### WARNING!

Limited-use spares are for emergency use only. Installation of this limited-use spare tire affects vehicle handling. With this tire, do not drive more than the speed listed on the limit-use spare wheel. Keep inflated to the cold tire inflation pressures listed on your Tire and Loading Information Placard located on the driver's side B-Pillar or the rear edge of the driver's side door. Replace (or repair) the original equipment tire at the first opportunity and reinstall it on your vehicle. Failure to do so could result in loss of vehicle control.

## WHEEL AND WHEEL TRIM CARE

All wheels and wheel trim, especially aluminum and chrome plated wheels, should be cleaned regularly with a mild soap and water to prevent corrosion.

To remove heavy soil and/or excessive brake dust, use MOPAR Wheel Cleaner or equivalent or select a non-abrasive, non-acidic cleaner.

### CAUTION!

Do not use scouring pads, steel wool, a bristle brush, or metal polishes. Do not use oven cleaner. These products may damage the wheel's protective finish. Avoid automatic car washes that use acidic solutions or harsh brushes that may damage the wheel's protective finish. Only MOPAR Wheel Cleaner or equivalent is recommended.



# MAINTAINING YOUR VEHICLE

## REPLACEMENT BULBS

### Interior Bulbs

	<b>Bulb Number</b>
Courtesy/Reading Lamps (Incandescent)	578
Courtesy/Reading Lamps (Optional LED)	LED (Serviced at Authorized Dealer)
Glove Compartment Lamp	194
Cargo Lamp	579
Optional Door Map Pocket/Cupholder	LED (Serviced at Authorized Dealer)
For lighted switches, see your authorized dealer for replacement instructions.	

### Exterior Bulbs

	<b>Bulb Number</b>
Low Beam Headlamp	9006
High Beam Headlamp	9005
Front Park/Turn Signal	3757AK
Side Marker Lamp	168
Front Fog Lamp	PSX24W or 2504
Center High Mounted Stop Lamp (CHMSL)	LED (Serviced at Authorized Dealer)
License Lamp	168

### Exterior Bulbs – Rear (LED Version)

	<b>Bulb Number</b>
Rear Tail/Stop Lamp	LED (Serviced at Authorized Dealer)
Rear Tail (Liftgate) Lamp	LED (Serviced at Authorized Dealer)
Rear Turn Signal Lamp	WY21W or 7440A
Backup Lamp	W21W or 7440

### Exterior Bulbs – Rear (Bulb Version)

	<b>Bulb Number</b>
Rear Tail/Stop/Turn Signal Lamp	P27/7W or 3157
Rear Tail (Liftgate) Lamp	P27/7W or 3157
Backup Lamp	P27/7W or 3157

# CONSUMER ASSISTANCE

## FCA US LLC CUSTOMER CENTER

P.O. Box 21-8004 Auburn Hills, MI 48321-8004 Phone: 1-800-423-6343

## FCA CANADA INC. CUSTOMER CENTER

P.O. Box 1621 Windsor, Ontario N9A 4H6 Phone: 1-800-465-2001 (English) Phone: 1-800-387-9983 (French)

## ASSISTANCE FOR THE HEARING IMPAIRED

To assist customers who have hearing difficulties, the manufacturer has installed special TDD (Telecommunication Devices for the Deaf) equipment at its customer center. Any hearing or speech impaired customer, who has access to a TDD or a conventional teletypewriter (TTY) in the United States, can communicate with the manufacturer by dialing 1-800-380-CHRY. Canadian residents with hearing difficulties that require assistance can use the special needs relay service offered by Bell Canada. For TTY teletypewriter users, dial 711 and for Voice callers, dial 1-800-855-0511 to connect with a Bell Relay Service operator.

### WARNING!

Engine exhaust, some of its constituents, and certain vehicle components contain, or emit, chemicals known to the State of California to cause cancer and birth defects, or other reproductive harm. In addition, certain fluids contained in vehicles and certain products of component wear contain, or emit, chemicals known to the State of California to cause cancer and birth defects, or other reproductive harm.

## PUBLICATIONS ORDERING

- If you are the first registered retail owner of your vehicle, you may obtain a complimentary printed copy of the Owner's Manual, Navigation/Uconnect Manuals or Warranty Booklet. United States customers may visit the Dodge Contact Us page at [www.dodge.com](http://www.dodge.com) scroll to the bottom of the page and select the "Contact Us" link, then select the "Owner's Manual and Glove Compartment Material" from the left menu. You may also obtain a complimentary copy by calling 1-800-423-6343 (U.S.) or 1-800-387-1143 (Canada).
- Replacement User Guide kits or DVDs or, if you prefer, additional printed copies of the Owner's Manual, Warranty Booklet or Radio Manuals may be purchased by visiting [www.techauthority.com](http://www.techauthority.com) or by calling 1-800-890-4038 (U.S.) or 1-800-387-1143 (Canada). Visa, Master Card, American Express and Discover orders are accepted. If you prefer mailing your order, please call the above numbers for an order form.

**NOTE:**

- A street address is required when ordering manuals (no P.O. Boxes).
- The Owner's Manual and User Guide electronic files are also available on the Chrysler, Jeep®, Ram Truck, Dodge and SRT websites.
- Click on the "For Owners" tab, select "Owner/Service Manuals", then select your desired model year and vehicle from the drop down lists.

## REPORTING SAFETY DEFECTS IN THE UNITED STATES

If you believe that your vehicle has a defect that could cause a collision or cause injury or death, you should immediately inform the National Highway Traffic Safety Administration (NHTSA) in addition to notifying the manufacturer.

If NHTSA receives similar complaints, it may open an investigation, and if it finds that a safety defect exists in a group of vehicles, it may order a recall and remedy campaign. However, NHTSA cannot become involved in individual problems between you, your authorized dealer and the manufacturer.

To contact NHTSA, you may either call the Auto Safety Hotline toll free at 1-888-327-4236 (TTY: 1-800-424-9153), or go to <http://www.safercar.gov>; or write to: Administrator, NHTSA, 1200 New Jersey Avenue, SE., West Building, Washington, D.C. 20590. You can also obtain other information about motor vehicle safety from <http://www.safercar.gov>.

### In Canada

If you believe that your vehicle has a safety defect, you should contact the Customer Service Department immediately. Canadian customers who wish to report a safety defect to the Canadian government should contact Transport Canada, Motor Vehicle Defect Investigations and Recalls at 1-800-333-0510 or go to <http://www.tc.gc.ca/roadsafety/>.

French Canadian customers who wish to report a safety defect to the Canadian government should contact Transport Canada, Motor Vehicle Defect Investigations and Recalls at 1-800-333-0510 or go to <http://www.tc.gc.ca/securiteroutiere/>.

## AUTHENTIC ACCESSORIES BY MOPAR

- The following highlights just some of the many Authentic Dodge Accessories by Mopar featuring a fit, finish, and functionality specifically for your Dodge Journey.
- In choosing Authentic Accessories you gain far more than expressive style, premium protection, or extreme entertainment, you also benefit from enhancing your vehicle with accessories that have been thoroughly tested and factory-approved.
- For the full line of Authentic Dodge Accessories by Mopar, visit your local dealership or online at [mopar.com](http://mopar.com) for U.S. residents and [mopar.ca](http://mopar.ca) for Canadian residents.

### NOTE:

All parts are subject to availability.

#### CHROME:

- Bodyside Moldings
- Fuel Filler Door
- Exhaust Tip
- Mirror Covers

#### EXTERIOR:

- Fog Lights
- Molded Splash Guards
- Front Air Deflector
- Hitch Receiver

#### INTERIOR:

- Cargo Tray
- Slush Mats
- Door Sill Guards
- Premium Carpet Floor Mats
- Katzkin Leather Interiors

#### ELECTRONICS:

- Park Assist
- Mopar Web (Wi-Fi)
- Electronic Vehicle Tracking System

#### CARRIERS:

- Hitch-Mount Bike Carrier
- Roof Mount Bike Carrier
- Roof Box Cargo Carrier
- Roof Mount Ski and Snowboard Carrier
- Roof Mount Water Sports Carrier
- Roof Mount Canoe Carrier

# FREQUENTLY ASKED QUESTIONS

## FAQ's

### GETTING STARTED

- How do I install my LATCH Equipped Child Seat? pg. 22
- How do I move my rear seats? pg. 31

### ELECTRONICS

- How do I know which radio I have?
  - Uconnect 4.3 & 4.3S pg. 52
  - Uconnect 8.4 & 8.4N pg. 54
- How do I select the AUX music source? pg. 67
- How do I set the clock on my radio?
  - Uconnect 4.3 & 4.3S pg. 52
  - Uconnect 8.4 & 8.4N pg. 54
- How do I use the Navigation feature? pg. 63
- How do I pair my cell phone via Bluetooth with the Uconnect Hands-Free Voice Activation System? pg. 68
- How do I hear the audio from my iPod through the USB port using the radio?
  - Uconnect 4.3 & 4.3S pg. 67
  - Uconnect 8.4 & 8.4N pg. 67
- How do I configure my Universal Garage Door Opener (HomeLink)? pg. 81

### UTILITY

- How do I know how much I can tow with my Dodge Journey? pg. 87

### WHAT TO DO IN EMERGENCIES

- What do I do if my TPMS warning light is blinking? pg. 90
- How do I change a flat tire? pg. 96
- How do I Jump-Start my vehicle? pg. 104

### MAINTAINING YOUR VEHICLE

- Where is my Fuse Block located?
  - Interior Fuses pg. 121
  - Underhood Fuses pg. 122
- What type of oil do I use? pg. 114
- How often should I change my engine's oil? pg. 116
- What should my tire pressure be set at? pg. 124

# INDEX

- Accessories . . . . .130
  - Mopar . . . . .130
- Adding Engine Coolant (Antifreeze) . .116
- Adding Washer Fluid . . . . .116
- Aftermarket . . . . .3
- Air Bag
  - Advanced Front Air Bag . . . . .15
  - Advance Front Air Bag . . . . .15
  - Air Bags . . . . .15
  - Air Bag Warning Light . . .15, 18, 90
  - Driver Knee Air Bag . . . . .16
  - Enhanced Accident Response . . . . .18, 108
  - Event Data Recorder (EDR) . .19, 108
  - Front Air Bag . . . . .15
  - Passenger Knee Air Bag . . . . .16
  - Rollover . . . . .15
  - Side Air Bags . . . . .17
  - Side Impacts . . . . .15
- Air Bag Light . . . . .18
- Air Cleaner, Engine
  - (Engine Air Cleaner Filter) . . . . .116
- Air Conditioner Maintenance . . . . .116
- Air Conditioning . . . . .41
- Air Conditioning Refrigerant . . . . .116
- Air Conditioning System . . . . .116
- Alarm
  - Vehicle Security Alarm . . . . .14
- Alarm (Security Alarm) . . . . .14, 94
- Antifreeze (Engine Coolant) . . .114, 116
  - Disposal . . . . .116
- Anti-Lock Brake System (ABS) . . . . .89
- Appearance Care . . . . .116
- Arming System (Security Alarm) . . . .14
- Assistance Towing . . . . .89
- Automatic Headlights . . . . .38
- Automatic Oil Change Indicator . . . . .94
- Automatic Temperature Control
  - (ATC) . . . . .41
- Automatic Transmission
  - Adding Fluid . . . . .115
  - Fluid Type . . . . .115
- Back-Up Camera . . . . .45
- Battery . . . . .116
  - Charging System Light . . . . .89
- Body Mechanism Lubrication . . . . .116
- Brake Fluid . . . . .115
- Brakes . . . . .116
- Brake System . . . . .116
  - Fluid Check . . . . .115
  - Master Cylinder . . . . .116
  - Warning Light . . . . .92
- Break-In Recommendations,
  - New Vehicle . . . . .36
- Bulb Replacement . . . . .127
- Bulbs, Light . . . . .127
- Calibration, Compass . . . . .79
- Canada . . . . .3, 129
- Capacities, Fluid . . . . .114
- Caps, Filler
  - Oil (Engine) . . . . .116
- Car Washes . . . . .116
- Changing A Flat Tire . . . . .96
- Charging System Light . . . . .89
- Check Engine Light
  - (Malfunction Indicator Light) . . . .93
- Child Restraint . . . . .20
- Child Restraints . . . . .19
  - Lower Anchors And Tethers For Children . . . . .20
- Child Seat Installation . . . . .19
- Cleaning
  - Wheels . . . . .116
  - Windshield Wiper Blades . . . . .116
- Climate Control . . . . .41
- Cluster Warning/Indicator Lights
  - Air Bag Warning Light . . . . .90
  - Brake Warning Light . . . . .92
  - Electronic Speed Control ON Indicator . . . . .94
  - Electronic Speed Control SET Indicator . . . . .94
  - Front Fog Light Indicator . . . . .94
  - High Beam Indicator . . . . .94
  - Turn Signal Indicator . . . . .94
  - Vehicle Security Light . . . . .94
- Clutch . . . . .116
- Clutch Fluid . . . . .116
- Compact Spare Tire . . . . .125
- Compass Calibration . . . . .79
- Cooling System . . . . .116
  - Adding Coolant (Antifreeze) . . . .116
  - Coolant Capacity . . . . .114
  - Coolant Level . . . . .116

- Disposal Of Used Coolant . . . . .116
- Drain, Flush, And Refill . . . . .116
- Inspection . . . . .116
- Points To Remember . . . . .116
- Pressure Cap . . . . .116
- Selection Of Coolant  
(Antifreeze) . . . . .114, 116
- Corrosion Protection . . . . .116
- Cruise Control (Speed Control) . . . . .39
- Cruise Light . . . . .39
- Customer Assistance. . . . .128, 129
- Customer Programmable  
Features . . . . .80, 81
- Defects, Reporting . . . . .129
- Disabled Vehicle Towing. . . . .89
- Disarming, Security System. . . . .14
- Disposal  
Antifreeze (Engine Coolant) . . . . .116
- Driver Cockpit . . . . .48
- E-85 Fuel. . . . .115
- Electronics. . . . .3  
Your Vehicle's Sound System . . . . .48
- Electronic Speed Control  
(Cruise Control). . . . .39
- Electronic Throttle Control Warning  
Light . . . . .90
- Electronic Vehicle Information Center  
(EVIC) . . . . .79, 80
- Electronic Vehicle Information Center  
(EVIC) Display . . . . .6
- Emergencies, What To Do In . . . . .89
- Emergency. . . . .89
- Emergency, In Case Of  
Freeing Vehicle When Stuck . . .107  
Jacking . . . . .96  
Overheating . . . . .95  
Towing . . . . .89
- Engine  
Air Cleaner . . . . .116  
Break-In Recommendations . . . . .36  
Checking Oil Level . . . . .116  
Compartment . . . . .110, 112  
Coolant (Antifreeze) . . . . .114  
Cooling . . . . .116  
Malfunction Indicator  
(Check Engine) . . . . .93
- Oil . . . . .114, 116  
Oil Change Interval . . . . .94  
Oil Filler Cap . . . . .116  
Oil Selection . . . . .114, 116  
Overheating . . . . .95
- Enhanced Accident Response  
Feature . . . . .108
- Ethanol . . . . .115
- EVIC Display. . . . .6
- Exhaust System . . . . .116
- FAQ . . . . .131
- Filters  
Air Cleaner . . . . .116  
Engine Oil . . . . .114, 116  
Engine Oil Disposal . . . . .116
- Flashers  
Turn Signal . . . . .94
- Flexible Fuel Vehicles  
Fuel Requirements . . . . .115
- Fluid, Brake . . . . .115
- Fluid Capacities . . . . .114
- Fluid Level Checks  
Brake . . . . .115  
Power Steering . . . . .115
- Fluids, Lubricants And Genuine  
Parts. . . . .114
- Fog Lights . . . . .38, 94
- Folding Front Passenger Seat . . . . .30
- Folding Rear Seat . . . . .31
- Freeing A Stuck Vehicle . . . . .107
- Frequently Asked Questions. . . . .131
- Front Heated Seats . . . . .33
- Fuel  
Ethanol . . . . .115  
Octane Rating . . . . .114  
Specifications . . . . .114  
Tank Capacity . . . . .114
- Fuel, Flexible. . . . .115
- Fuses . . . . .121
- Garage Door Opener (HomeLink). .81, 83
- Gauges  
Speedometer . . . . .6  
Tachometer . . . . .6
- General Maintenance . . . . .116
- Glass Cleaning . . . . .116

# INDEX

- GPS Navigation (Uconnect GPS) . . . . .63
- Headlights
  - Automatic . . . . .38
  - Cleaning . . . . .116
- Head Restraints . . . . .26
- Heated Mirrors . . . . .44
- Heated Seats . . . . .33
- Heated Steering Wheel . . . . .34
- High Beam Indicator . . . . .94
- HomeLink
  - Operation . . . . .83
- HomeLink (Garage Door Opener) .81, 83
- Hood Release . . . . .109
- Identifying Your Radio . . . . .51
- Installing A Child Restraint With
  - ALR . . . . .22
- Installing Child Restraints Using The
  - LATCH Lower Anchorages . . . . .22
- Instrument Cluster . . . . .6
  - Indicators . . . . .6
- Instrument Panel Cover . . . . .116
- Instrument Panel Lens Cleaning . .116
- Interior And Instrument Lights . . . . .5
- Interior Appearance Care . . . . .116
- Interior Fuses . . . . .121
- Intermittent Wipers (Delay Wipers) . .37
- Introduction . . . . .2
  - Aftermarket Electronics . . . . .3
  - Canada . . . . .3
- Inverter Outlet (115V) . . . . .84
- Inverter, Power . . . . .84
- iPod/USB/MP3 Control . . . . .61, 67
  - Bluetooth Streaming Audio . . . . .68
- Jacking Instructions . . . . .99
- Jack Location . . . . .96
- Jack Operation . . . . .96, 99
- Jump Starting . . . . .104
- Key Fob . . . . .8
  - Lock The Doors . . . . .8
  - Unlock The Doors . . . . .8
- Keyless Enter-N-Go . . . . .10
  - Key Fob . . . . .10
  - Lock/Unlock . . . . .10, 11, 12
  - Passive Entry . . . . .10
- Remote Control . . . . .10
- Lane Change Assist . . . . .37
- Lap/Shoulder Belts . . . . .14
- Left Switch
  - Steering Wheel Audio Controls . . .78
- Light Bulbs . . . . .127
- Lights
  - Air Bag . . . . .18
  - Engine Temperature Warning . . .91
  - Fog . . . . .94
  - High Beam Indicator . . . . .94
  - Low Fuel . . . . .89
  - Seat Belt Reminder . . . . .92
  - Security Alarm . . . . .94
  - Service . . . . .127
- Locks
  - Liftgate, Tailgate . . . . .8
- Lower Anchors And Tether For Children (LATCH) . . . . .20
- Lubrication, Body . . . . .116
- Maintaining Your Vehicle . . . . .109
- Maintenance . . . . .109
- Maintenance Free Battery . . . . .116
- Maintenance, General . . . . .109, 116
- Maintenance Procedures . . . . .116
- Maintenance Record . . . . .120
- Malfunction Indicator Light (Check Engine) . . . . .93
- Master Cylinder (Brakes) . . . . .116
- Mirrors
  - Heated . . . . .44
- Mopar . . . . .130
- MOPAR Accessories . . . . .130
- Navigation Voice Commands . . . . .76
- Navigation Voice Prompt Volume . . .75
- New Vehicle Break-In Period . . . . .36
- Octane Rating, Gasoline (Fuel) . . . .114
- Oil Change Indicator . . . . .94
- Oil Change Indicator, Reset . . . . .94
- Oil, Engine . . . . .114, 116
  - Capacity . . . . .114
  - Change Interval . . . . .94, 116
  - Checking . . . . .116
  - Disposal . . . . .116



- Filter . . . . .114, 116
- Filter Disposal . . . . .116
- Materials Added To . . . . .116
- Recommendation . . . . .114, 116
- Viscosity . . . . .114, 116
- Oil Filter, Selection. . . . .116
- Outlet
  - Power . . . . .85
- Overheating, Engine. . . . .95
- Paint Care . . . . .116
- Panic Alarm . . . . .8
- Phone (Uconnect) . . . . .68
- Pinch Protection. . . . .47
- Placard, Tire And Loading
  - Information . . . . .124
- Power
  - Distribution Center (Fuses) . . . .122
  - Inverter . . . . .84
  - Outlet
    - (Auxiliary Electrical Outlet) . . . .85
  - Seats . . . . .28
- Power Steering Fluid. . . . .115
- Power Transfer Unit . . . . .115
- Preparation For Jacking . . . . .97
- Programmable Electronic Features . .80
- Radio
  - Presets . . . . .56
- Radio Operation . . . . .56
- Radio (Sound Systems). . . . .52, 54
- Rain Sensitive Wiper System . . . . .37
- Rear Camera . . . . .45
- Rear ParkSense System . . . . .45
- Rear Seat, Folding. . . . .31
- Recreational Towing . . . . .88
- Refrigerant . . . . .116
- Remote Keyless Entry (RKE)
  - Lock The Doors . . . . .8
  - Remote Keyless Entry (RKE) . . . .8
  - Unlock The Doors . . . . .8
- Replacement Bulbs . . . . .127
- Reporting Safety Defects . . . . .129
- Resetting Oil Change Indicator . . . .94
- Restraint, Head . . . . .26
- Rocking Vehicle When Stuck . . . . .107
- Satellite Radio (Uconnect Studios) . .58
- Seat Belt
  - Seat Belt Pretensioner . . . . .14
- Seat Belt Maintenance . . . . .116
- Seat Belts . . . . .14
  - Adjustable Shoulder Belt . . . . .14
  - Pretensioners . . . . .14
  - Reminder . . . . .92
- Seats. . . . .28, 29
  - Adjustment . . . . .29
  - Folding Front Passenger . . . . .30
  - Heated . . . . .33
  - Manual . . . . .29
  - Power . . . . .28
  - Rear Folding . . . . .31
- Security Alarm . . . . .94
  - Security Alarm . . . . .14
- Selection Of Coolant (Antifreeze) . .114
- Shift Lever Override . . . . .106
- Signals, Turn . . . . .37, 94
- SIRIUS Travel Link . . . . .66
- Spare Tire . . . . .96, 125, 126
- Spark Plugs . . . . .114
- Specifications
  - Fuel (Gasoline) . . . . .114
  - Oil . . . . .114
- Speed Control
  - Accel/Decel . . . . .39
  - Cancel . . . . .40
  - Resume . . . . .40
  - Set . . . . .39
- Steering
  - Tilt Column . . . . .35
  - Wheel, Heated . . . . .34
- Steering Wheel Audio Controls . . . .78
- Stuck, Freeing . . . . .107
- Sunroof
  - Closing . . . . .46
  - Opening . . . . .46
  - Venting . . . . .46
- Supplemental Restraint System -
  - Air Bag . . . . .15
- Temperature Control, Automatic
  - (ATC) . . . . .41
- Tether Anchor, Child Restraint . . .22, 23
- Tilt Steering Column. . . . .35
- Tires . . . . .124, 125
  - Air Pressure . . . . .124

# INDEX

- Changing . . . . .96
- Compact Spare . . . . .125
- General Information . . . . .124, 125
- Jacking . . . . .96
- Pressure Warning Light . . . . .90
- Spare Tire . . . . .96, 125, 126
- Towing . . . . .87
  - Behind A Motorhome . . . . .88
  - Disabled Vehicle . . . . .107
  - Recreational . . . . .88
- Towing Vehicle Behind A Motorhome . .88
- Traction Control . . . . .94
- Trailer Towing
  - Trailer And Tongue Weight . . . . .87
- Trailer Weight . . . . .87
- Transmission
  - Fluid . . . . .116
  - Maintenance . . . . .116
- Turn Signals . . . . .37, 94
- Uconnect Voice Command . . . . .75
- Underhood Fuses . . . . .122
- Universal Garage Door Opener
  - (HomeLink) . . . . .81
- USB Port . . . . .67
- Using The Top Tether Anchorage . . . .23
- Video Entertainment System
  - (Rear Seat Video System) . . . . .77
- Voice Command . . . . .75
- Washer
  - Adding Fluid . . . . .116
  - Rear . . . . .37
- Washers, Windshield . . . . .37
- Washing Vehicle . . . . .116
- Wheel And Wheel Trim . . . . .116
- Wheel And Wheel Trim Care . . .116, 126
- Wind Buffeting . . . . .47
- Windshield Washers . . . . .37
- Windshield Wiper Blades . . . . .116
- Windshield Wipers . . . . .37
- Wiper Blade Replacement . . . . .116
- Wiper, Rear . . . . .37

## DODGE.COM (U.S.) DODGE.CA (CANADA)

This guide has been prepared to help you get quickly acquainted with your new Dodge vehicle and to provide a convenient reference source for common questions. However, it is not a substitute for your Owner's Manual.

For complete operational instructions, maintenance procedures and important safety messages, please consult your Owner's Manual, Navigation/Uconnect Manuals and other Warning Labels in your vehicle.

Not all features shown in this guide may apply to your vehicle. For additional information on accessories to help personalize your vehicle, visit [www.mopar.com](http://www.mopar.com) (U.S.), [www.mopar.ca](http://www.mopar.ca) (Canada) or your local Dodge brand dealer.



## DRIVING AND ALCOHOL

Drunken driving is one of the most frequent causes of accidents. Your driving ability can be seriously impaired with blood alcohol levels far below the legal minimum. If you are drinking, don't drive. Ride with a designated non-drinking driver, call a cab, a friend, or use public transportation.

## WARNING!

Driving after drinking can lead to an accident. Your perceptions are less sharp, your reflexes are slower, and your judgment is impaired when you have been drinking. Never drink and then drive.

DOWNLOAD A FREE  
ELECTRONIC COPY OF THE OWNER'S  
MANUAL AND WARRANTY BOOKLET

BY VISITING:

[WWW.DODGE.COM/EN/OWNERS/MANUALS](http://WWW.DODGE.COM/EN/OWNERS/MANUALS)  
OR [WWW.DODGE.COM/EN/WARRANTY](http://WWW.DODGE.COM/EN/WARRANTY) (U.S.);  
[WWW.OWNERS.MOPAR.CA/EN](http://WWW.OWNERS.MOPAR.CA/EN) (CANADA).

© 2015 FCA US LLC. ALL RIGHTS RESERVED.  
DODGE IS A REGISTERED TRADEMARK OF FCA US LLC.

**DODGE** 



16JC49-926-AA  
JOURNEY

SECOND EDITION REV. 1  
USER GUIDE